

# ZENMUSE XT

POWERED BY 

## User Manual

V1.2 2016.05

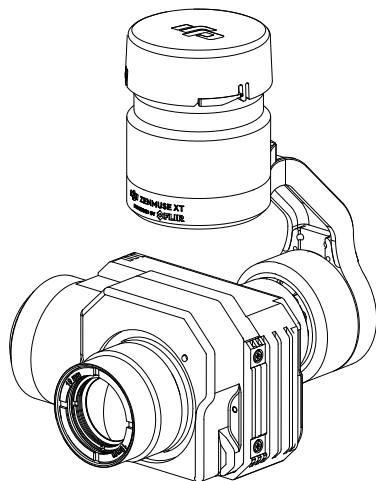

## Searching for Keywords

Search for keywords such as “battery” and “install” to find a topic. If you are using Adobe Acrobat Reader to read this document, press Ctrl+F on Windows or Command+F on Mac to begin a search.

## Navigating to a Topic

View a complete list of topics in the table of contents. Click on a topic to navigate to that section.

## Printing this Document

This document supports high resolution printing.

# Using this Manual

## Legend

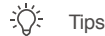

## Install the DJI GO App

Search for ‘DJI GO’ on the App Store or Google Play and install the app on your mobile device.



---

 DJI GO supports iOS 8.0 (or later) or Android 4.1.2 (or later).

---

## ECCN (Export Control Classification Number)

This Zenmuse™ XT product, its components, related technology and software are controlled under the U.S. Export Administration Regulation, the Export Control Classification Number (ECCN) for this product is 6A003.b.4.b.

Refer to the link below for more information:

[https://www.google.com/url?sa=t&rct=j&q=&esrc=s&source=web&cd=1&ved=0ahUKEwi2icCmsPDKAhUDmpQKH0QCCgQFggdMAA&url=https%3A%2F%2Fwww.bis.doc.gov%2Findex.php%2Fforms-documents%2Fdoc\\_download%2F952-ccl6&usg=AFQjCNHsPeNR-BmXMMn9CLgKU35KjewWPw&cad=rja](https://www.google.com/url?sa=t&rct=j&q=&esrc=s&source=web&cd=1&ved=0ahUKEwi2icCmsPDKAhUDmpQKH0QCCgQFggdMAA&url=https%3A%2F%2Fwww.bis.doc.gov%2Findex.php%2Fforms-documents%2Fdoc_download%2F952-ccl6&usg=AFQjCNHsPeNR-BmXMMn9CLgKU35KjewWPw&cad=rja)

# Content

Using this Manual	2
Legend	2
Install the DJI GO App	2
ECCN (Export Control Classification Number)	2
Introduction	4
Installation	4
Supported Aircraft	4
Mounting the Zenmuse XT on the Inspire 1	4
Mounting the Zenmuse XT on the Matrice 100	5
DJI GO App	6
Downloading DJI GO	6
Connecting to DJI GO	6
Settings	7
Remote Controller Operations	16
Specifications	17

# Introduction

The Zenmuse XT gimbal and camera features the FLIR Longwave Infrared Thermal Camera. It provides high-sensitivity (<50 mK@f/1.0) infrared imaging at 640/30 fps or 336/30 fps depending on the camera model, and comes with 6.8 mm, 7.5 mm, 9 mm, 13 mm or 19 mm lens options.

As with other DJI 3-axis gimbal systems, the Zenmuse XT can be mounted on the Matrice 100 or Inspire 1 series aircraft and stream a live HD view to DJI GO. This makes it excellent for aerial thermal applications such as inspection and maintenance, search and rescue, and precision agriculture.

There are two versions of the Zenmuse XT gimbal and camera: the Zenmuse XT-Performance and Zenmuse XT-Radiometry. The general descriptions in this manual apply to both versions.

## Zenmuse XT

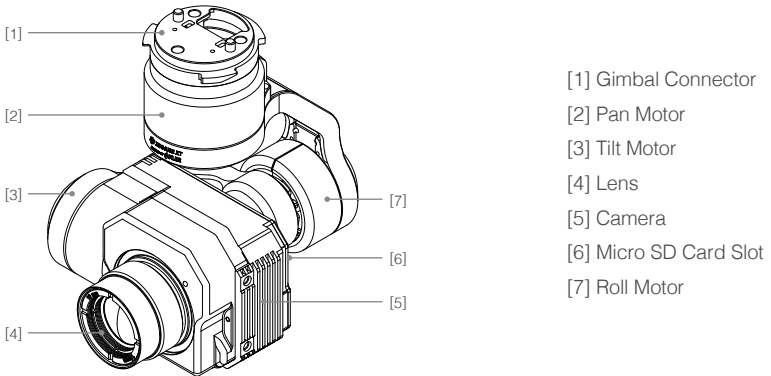

# Installation

## Supported Aircraft

DJI Inspire 1

DJI Inspire 1 V2.0

DJI Matrice 100

## Mounting the Zenmuse XT on the Inspire 1

The Zenmuse XT can be mounted on the Inspire 1 aircraft in place of the Zenmuse X3.

1. Remove the gimbal cap and the lens cap.

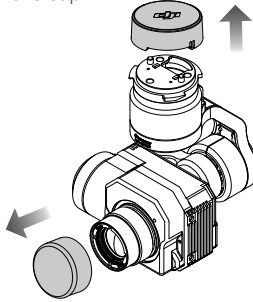

2. Rotate the gimbal lock on the Inspire 1 to the unlocked position. With the white lines aligned, insert the gimbal.
3. Rotate the gimbal lock to the locked position.

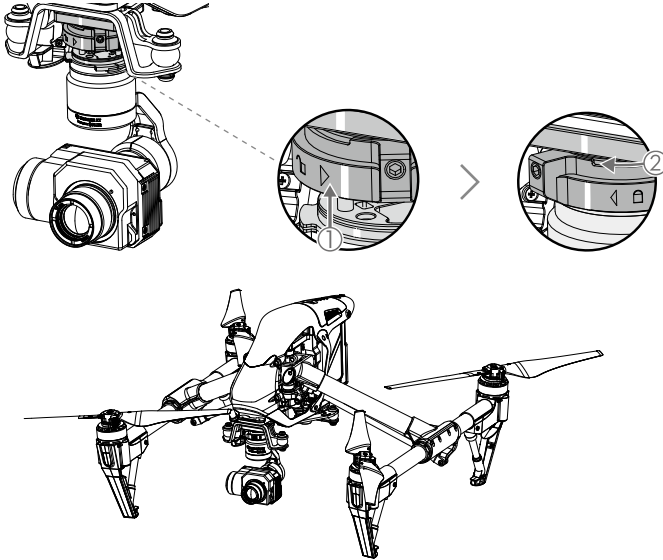

## Mounting the Zenmuse XT on the Matrice 100

The Matrice 100 aircraft has to be modified before mounting the Zenmuse XT. Refer to "Mounting the Gimbal" in the *Matrice 100 User Manual* for detailed procedures.

The following parts are required for the installation.

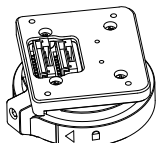

Gimbal Lock

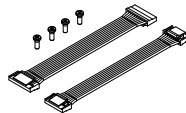

Gimbal Cables and Screws

The mounted Zenmuse XT should look like this.

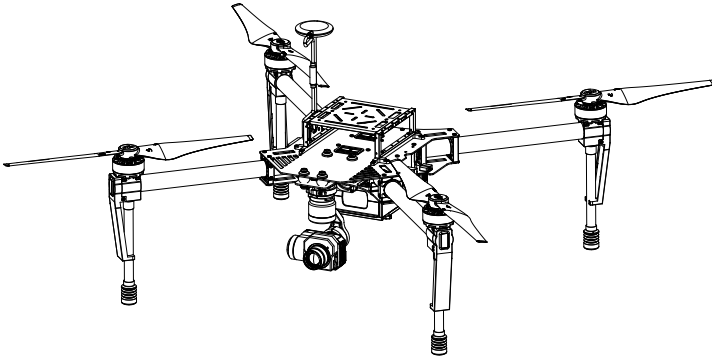

- Ensure the Zenmuse XT is mounted securely.
  - The Zenmuse XT is a delicate instrument. Do not disassemble the gimbal or camera as this will cause permanent damage.
- 

## DJI GO App

### Downloading DJI GO

Search for 'DJI GO' on the App Store or Google Play and download the app to your mobile device.



DJI GO supports iOS 8.0 (or later) or Android 4.1.2 (or later).

---

### Connecting to DJI GO

1. Turn on the aircraft and the remote controller.
2. Connect your mobile device to the remote controller using a USB cable.

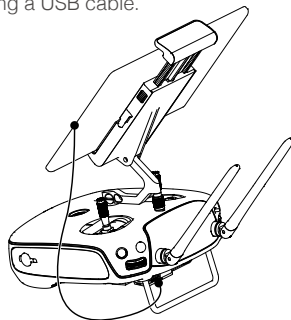
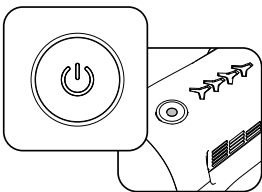

3. Launch DJI GO and enter Camera View. You will see real-time video from the camera when a connection is established.

## Settings

### 1. Camera View

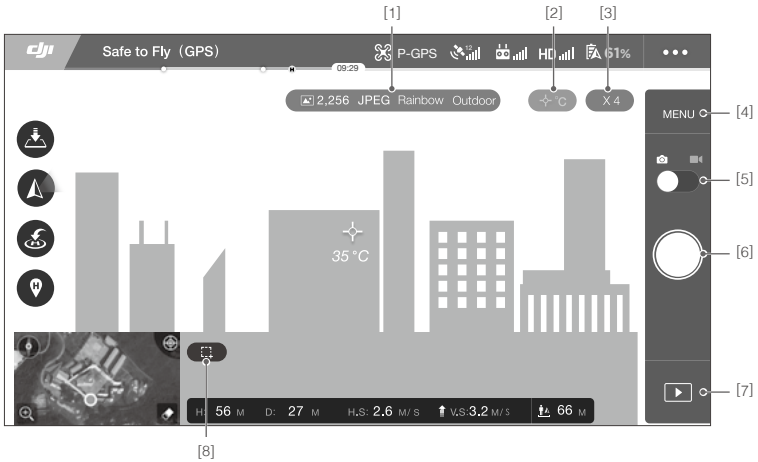

#### [1] Information Bar

Displays the remaining shots or recording time, photo/video format, and selected palette and scene.

#### [2] Spot Meter/Area Measurement

Tap to enable the Spot Meter or Area Measurement (Zenmuse XT-Radiometric Only).

#### [3] Digital Zoom

Tap to adjust digital zoom.

#### [4] Camera Settings

Tap to view the camera settings.

#### [5] Photo/Video Mode

Switch between photo and video mode.

#### [6] Shutter/Record Button

Shoot photos or video depending on the camera mode.

#### [7] Playback

Tap to view photos and videos on your Micro SD card.

#### [8] Screenshot Button

Tap to capture a screenshot and save it to your mobile device.

## 2. Camera Settings

### 1) Photos

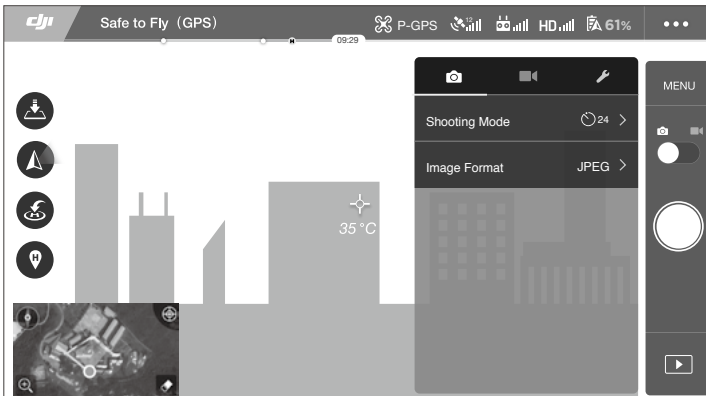

Shooting Mode: Single Shot or Interval Timer (1-60 second intervals).

Image Format: JPEG (8-bit) or R-JPEG (Radiometric JPEG). The Zenmuse XT-Radiometric supports four image file formats: JPEG, R-JPEG, TIFF T-Linear Low, and TIFF T-Linear High, which is more useful for thermal imaging analysis.

### 2) Video



Video Format: NTSC 30fps, PAL 25fps.

\*The camera can only shoot R-JPEG format photos when recording video.



### 3) General Settings



#### ROI (Region of Interest)

Use this feature to manage color range distribution across the screen to maximize contrast for regions of highest interest.

If you want the color spectrum to be evenly distributed across the entire image, select "Full".

If there is large patch of sky (relatively low temperature) in your image, much of the color spectrum will be allocated to the lower range, meaning other parts of the spectrum will have less contrast. In this case, you may select "Sky excluded (33%)" or "Sky excluded (50%)" to ignore areas of the sky so that most of the spectrum can be allocated to remaining areas, providing higher contrast and utility for analysis.

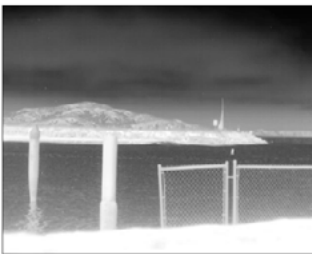

ROI set to "Full"











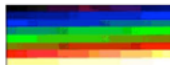

Sky excluded from ROI

#### Palette

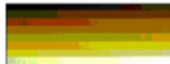
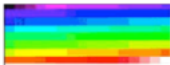
The Zenmuse XT offers a variety of Palette options. Distinct colors are used to show temperature differences in the thermal image, which are related to the grayscale intensity. The temperature range of the image is mapped to 256 colors and displayed in the 8-bit JPEG or MPEG-4 format.

The following table shows all Palette options.

<p>Cold</p>  <p>Hot</p> <p><b>White Hot</b></p>	<p>Cold</p>  <p>Hot</p> <p><b>Black Hot</b></p>	<p>Cold</p>  <p>Hot</p> <p><b>Fusion</b></p>	<p>Cold</p>  <p>Hot</p> <p><b>Rainbow</b></p>
<p>Cold</p>  <p>Hot</p> <p><b>Glowbow</b></p>	<p>Cold</p>  <p>Hot</p> <p><b>Ironbow1</b></p>	<p>Cold</p>  <p>Hot</p> <p><b>Ironbow2</b></p>	<p>Cold</p>  <p>Hot</p> <p><b>Sepia</b></p>
<p>Cold</p>  <p>Hot</p> <p><b>Color1</b></p>	<p>Cold</p>  <p>Hot</p> <p><b>Color2</b></p>	<p>Cold</p>  <p>Hot</p> <p><b>Ice Fire</b></p>	<p>Cold</p>  <p>Hot</p> <p><b>Rain</b></p>

Different Palettes applied to the same image:

White Hot



Black Hot



Fusion

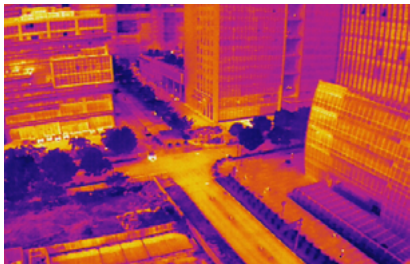

Rainbow

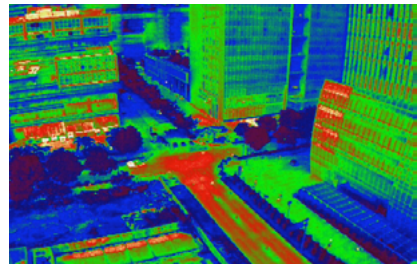

### Scene

Use the Scene option to instantly enhance your image. You can select Linear, Default, Sea/Sky, Outdoor, Indoor, Manual or Custom option. The camera will automatically apply the following properties to obtain the best result.

- DDE (Digital Detail Enhancement) enhances image details and/or suppresses fixed pattern noise.
- ACE (Active Contrast Enhancement) provides a contrast adjustment dependent on the relative scene temperature. ACE thresholds greater than 0 impart more contrast to hotter scene content and decrease contrast for colder scene content (e.g. sky or ocean). ACE thresholds less than 0 do the opposite by decreasing contrast for hotter scene content and leaving more of the gray-scale shades to represent the colder scene content.
- SSO (Smart Scene Optimization) defines the percentage of the histogram that will be allotted a linear mapping. SSO features facilitate the avoidance of irradiance level compression, which is specifically important for bi-modal scenes, and better preserves the radiometric aspects of an image (i.e. the difference in gray shades between two objects is more representative of the difference in temperature). While radiometry is better preserved with this feature, the compromise is the optimization of local contrast.
- Contrast: The ratio of the black and white of the image. The colors will be richer and have more contrast when the value is large.
- Brightness: The brightness of the image.

### Spot Meter

The Zenmuse XT-Radiometric can measure the temperature for any position in an image with an accuracy of  $\pm 10^{\circ}\text{C}$ . When environmental conditions are ideal, the camera provides an accuracy of  $\pm 5^{\circ}\text{C}$ .

The Zenmuse XT-Performance can also measure the average temperature of the 4x4 pixels in the center of an image with an accuracy of  $\pm 20^{\circ}\text{C}$  in High Gain mode, and an accuracy of 20% of the entire temperature range or  $20^{\circ}\text{C}$  (whichever is greater) in Low Gain mode.

### Area Measurement (Zenmuse XT-Radiometric Only)

Enabling this function will display the average temperature, lowest temperature, the highest temperature and the corresponding locations of each area in the DJI GO app. Full screen view also supported.

The spot meter's measurement accuracy is affected by various factors:

- 1) Reflectivity of objects - shiny metals with high reflectivity will reflect more of the background radiation, and result in a larger error; objects with matte surfaces will produce a higher accuracy.
- 2) Temperature of background radiation - a sunny day without clouds will have less of an effect on the accuracy than a cloudy day.
- 3) Air temperature and humidity - the higher the temperature and humidity, the lower the accuracy.
- 4) Distance between camera and object - the shorter the distance, the higher the accuracy.
- 5) Emissivity of objects - the higher the emissivity, the higher the accuracy.

### Temperature Alert (Zenmuse XT-Radiometric Only)

After enabling Area Measurement, you can set an alert value for the Temperature Alert function. When the highest temperature in the selected area exceeds the alert value, an on-screen notification will appear in the DJI GO app, accompanied by a beeping sound.

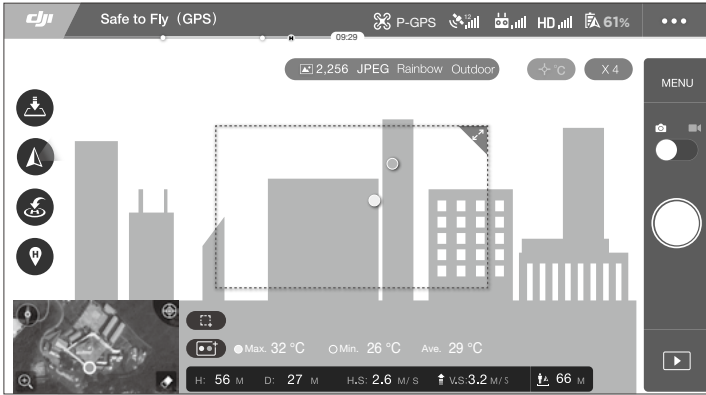

### Isotherm

Enabling Isotherm allows designated temperature ranges to be represented with different color schemes, so that objects measured in a single color scheme impart higher contrast and better visibility.

Individual isotherms (or color schemes) are separated by upper, middle and lower thresholds, which have a value in percentage or temperature.





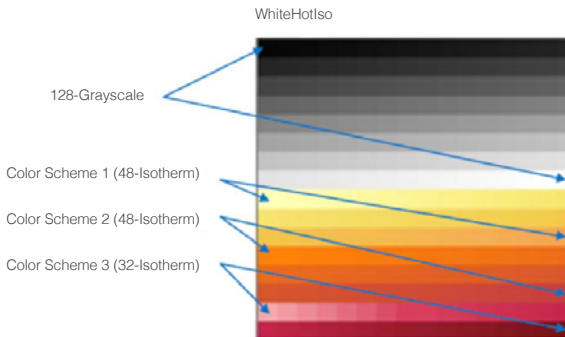

Take the White Hot Isotherm as an example. Below the lower threshold, 128-Grayscale is used to represent temperature differences.

Between the lower and middle thresholds, Color Scheme 1 (48-Isotherm) is used.

Between the middle and upper thresholds, Color Scheme 2 (48-Isotherm) is used.

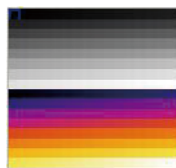
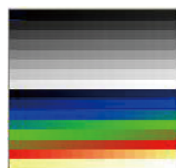
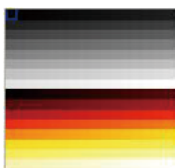
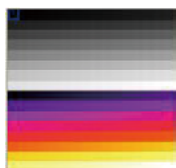
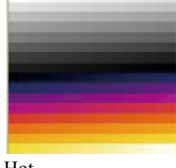
Above the upper threshold, Color Scheme 3 (32-Isotherm) is used.

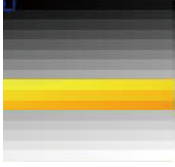
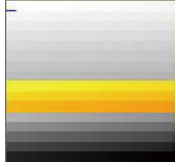
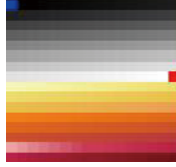

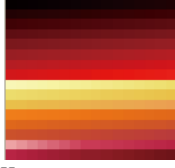
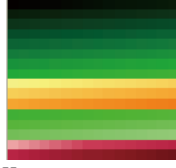
<p>Cold <b>WhiteHotIso</b></p>  <p>Hot</p>	<p>Cold <b>BlackHotIso</b></p>  <p>Hot</p>	<p>Cold <b>FusionIso</b></p>  <p>Hot</p>	<p>Cold <b>RainbowIso</b></p>  <p>Hot</p>
<p>Cold <b>GlowboIso</b></p>  <p>Hot</p>	<p>Cold <b>IronbowWhiteHotIso</b></p>  <p>Hot</p>	<p>Cold <b>IronbowBlackHotIso</b></p>  <p>Hot</p>	<p>Cold <b>SepiaIso</b></p>  <p>Hot</p>
<p>Cold <b>MidRangeWHIso</b></p>  <p>Hot</p>	<p>Cold <b>MidRangeBHIso</b></p>  <p>Hot</p>	<p>Cold <b>IceFireIso</b></p>  <p>Hot</p>	<p>Cold <b>RainbowHCIso</b></p>  <p>Hot</p>
<p>Cold <b>RedHotIso</b></p>  <p>Hot</p>	<p>Cold <b>GreenHotIso</b></p>  <p>Hot</p>		

White Hot Isotherm



Black Hot Isotherm



Fusion Isotherm



Rainbow Isotherm



### Gain Modes

High Gain Mode: The camera covers a smaller temperature range but is more sensitive to temperature differences.

Low Gain Mode: The camera covers a wider temperature range but is less sensitive to temperature differences.

Auto Gain Mode (Default): The camera will automatically select the optimal gain mode according to the temperature range of the image.

### External Parameters (Zenmuse XT-Radiometric Only)

The Scene Emissivity, Background Temperature and other external parameters can be set by the user to improve temperature measurement accuracy.

### Restore Factory Default Settings

Tap to restore the camera to the default settings.

### Format Micro SD Card

Tap to format your Micro SD card.

### FFC Calibration

Both Manual FFC calibration and Auto FFC calibration is supported.

The calibration is used to optimize image quality. A blue square in the upper right corner of the screen indicates that the FFC calibration is about to begin. During the calibration, your screen may freeze momentarily and the camera will make a clicking sound.



### 3. Units of Measurement



Units: Fahrenheit, Celsius and Kelvin.

# Remote Controller Operations

The remote controller offers a host of buttons and dials to change camera settings and capture images with the tap of your finger.

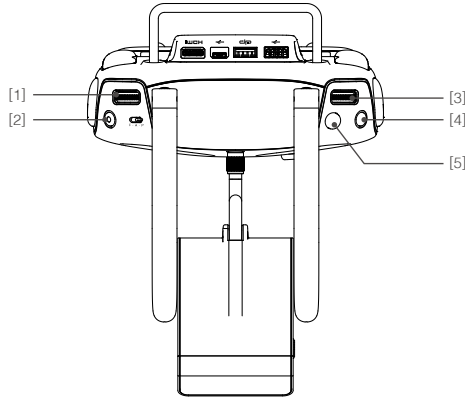

## [1] Left Dial

Turn to adjust the camera's tilt or pan.

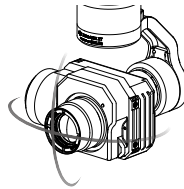

## [2] Record Button

Press to start/stop recording video.

## [3] Right Dial

Press to switch between the Palette (default) and digital zoom. Turn to adjust their values.

## [4] Playback Button

Press to view photos and videos on your Micro SD card. Press again to exit.

## [5] Shutter Button

Press to take photos.



# Specifications

General		
Name	Zenmuse XT	
Dimensions	103 mm x 74 mm x 102 mm	
Weight	270 g	
Gimbal		
Angular Vibration Range	±0.03°	
Mount	Detachable	
Controllable Range	Tilt: +30° to -90°; Pan: ±320°; Roll: ±15°	
Mechanical Range	Tilt: +45° to -135°; Pan: ±320°; Roll: ±45°	
Max Controllable Speed	120°/s	
Camera		
Thermal Imager	Uncooled VOx Microbolometer	
FPA/Digital Video Display Formats	640 × 512	336 × 256
Analog Video Display Formats	720 × 480 (NTSC); 720 × 576 (PAL)	
Pixel Pitch	17 μm	
Spectral Band	7.5-13.5 μm	
Full Frame Rates	30 Hz (NTSC); 25 Hz (PAL)	
Exportable Frame Rates	7.5 Hz (NTSC); 8.3 Hz (PAL)	
Sensitivity (NEΔT)	<50 mK at f/1.0	
Scene Range (High Gain)	-13° to 275° F (-25° to 135° C)	-13° to 212° F (-25° to 100° C)
Scene Range (Low Gain)	-40° to 1022° F (-40° to 550° C)	
Spot Meter	Measures the temperature of the 4x4 pixels in the center of the image (Zenmuse XT-Performance), or any position on the image (Zenmuse XT-Radiometric)	
File Storage	Micro SD Card	
Photo Format	JPEG, R-JPEG	
Video Format	MP4	
Video Recording Bitrate	2 Mbps	
Support SD Cards	Micro SD; Max capacity: 32 GB	
Image Processing & Display Controls		
NTSC/PAL (Field Switchable)	Yes	
Image Optimization	Yes	
Digital Detail Enhancement	Yes	
Polarity Control (Black Hot/White Hot)	Yes	
Color & Monochrome Palettes (LUTs)	Yes	
Digital Zoom	2x, 4x, 8x	2x, 4x

Lens Models		6.8 mm	7.5 mm	9 mm	13 mm	19 mm
17 $\mu$ 640x512	FoV iFoV	/	f/1.4 90° × 69° 2.267 mr	f/1.4 69° × 56° 1.889 mr	f/1.25 45° × 37° 1.308 mr	f/1.25 32° × 26° 0.895 mr
17 $\mu$ 336x256	FoV iFoV	f/1.4 49.1° × 37.4° 2.519 mr	/	f/1.25 35° × 27° 1.889 mr	f/1.25 25° × 19° 1.308 mr	f/1.25 17° × 13° 0.895 mr
Min Focus Distance		2.3 cm	2.5 cm	3.2 cm	7.6 cm	15.3 cm
Hyperfocal Distance		1.2 m	1.2 m	2.1 m	4.4 m	9.5 m
Hyperfocal Depth of Field		0.6 m	0.6 m	1.1 m	2.2 m	4.8 m
Environmental						
Operating Temperature		14° to 104° F (-10° to 40° C)				
Non-Operating Temperature		-22° to 158° F (-30° to 70° C)				
Temperature Shock		5° C/min				
Humidity		5% to 95%				

\* FLIR is the trademark of FLIR Systems, Inc.

DJI Support  
<http://www.dji.com/support>

This content is subject to change.

Download the latest version from  
<http://www.dji.com/product/zenmuse-xt>



If you have any questions about this document, please contact  
DJI by sending a message to **DocSupport@dji.com**.

ZENMUSE™ is a trademark of DJI.  
Copyright © 2016 DJI All Rights Reserved.