

ZENMUSE X5R

User Manual V1.0

2016.03

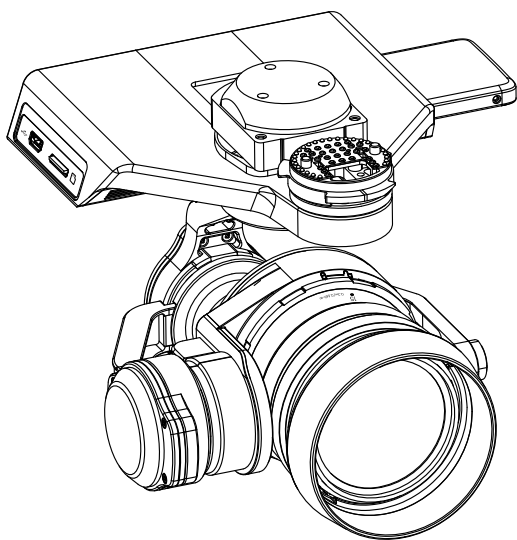

Searching for Keywords

Search for keywords such as “battery” and “install” to find a topic. If you are using Adobe Acrobat Reader to read this document, press Ctrl+F on Windows or Command+F on Mac to begin a search.

Navigating to a Topic

View a complete list of topics in the table of contents. Click on a topic to navigate to that section.

Printing this Document

This document supports high resolution printing.

Using this manual

Legends

 Warning

 Important

 Hints and Tips

 Reference

Before Flight

Read the following documents before using the Zenmuse X5R:

1. Zenmuse X5R In the Box
2. Zenmuse X5R User Manual
3. Zenmuse X5R Safety Guidelines and Disclaimer

Check that all of the items are included in the package. We recommend that you watch all tutorial videos on the official DJI website and read the Disclaimer and Safety Guidelines before you fly. Refer to the User Manual for more detailed information.

Watch the Video Tutorials

Please watch the tutorial videos at the link below, which demonstrates how to use Zenmuse X5R safely:

<http://www.dji.com/product/zenmuse-x5s/info#video>



Contents

Using this manual	2
Legends	2
Before Flight	2
Watch the Video Tutorials	2
Product Profile	4
Overview	4
In the Box	5
Optional Accessories	5
Components	6
Getting Started	7
Read the information below before setting up your Zenmuse X5R	7
Supported Devices	7
Supported Lenses for the Inspire 1	7
Required Lens Accessories	7
Supported Micro SD Cards	8
Supported X5R SSD	8
Installing the Camera Lens	8
Mounting the Zenmuse X5R to the Inspire 1	10
Replace the Inspire 1 Gimbal Mounting Plate	10
Attach the Zenmuse X5R	11
Mechanical Range	11
Operating the Camera	12
Camera Panel	12
Basic Shooting	12
Taking Photos	12
Recording Videos	12
Advanced Settings	13
Exposure Modes	13
Photo Styles	13
White Balance	13
List of Settings	14
Managing your Photos and Videos	15
Playback	15
Downloading your Files from Micro SD Card	15
DJI CineLight and your X5R SSD Files	16
Installing DJI CineLight	16
System Requirements	16
Installation (Installer is included on the X5R SSD)	16
Accessing your Files	17
Post-Processing with DJI CineLight	17
Appendix	22
Specifications	22

Product Profile

Overview

The Zenmuse X5R is the world's first fully integrated flying gimbal and camera system capable of capturing video in 4K Cinema RAW for high-end professional video production. The Type 4/3 CMOS sensor supports lossless 4K RAW video and 16 MP still photos, with shooting modes including burst, AEB and timelapse.

Integrated into the system is a dedicated 512GB X5R SSD that stores lossless 4K RAW video at up to 2.4Gbps and can be synced with DJI CineLight for post-processing RAW files. The optional lens kit includes the DJI MFT 15mm f/1.7 ASPH (30mm in 35mm format) with a 72-degree field of view.

When mounted on the Inspire 1 series, the 3-axis gimbal provides a stable platform for the camera to get clear shots even during maneuvers. The gimbal tilts the camera across a -90° to $+30^{\circ}$ pitch angle and pans $\pm 320^{\circ}$ in both directions. Live HD video from the camera is streamed to the DJI GO app.

In the Box

Check that all of the following items are in your package. If any item is missing, please contact DJI or your local dealer.

Zenmuse X5R Camera Body ×1

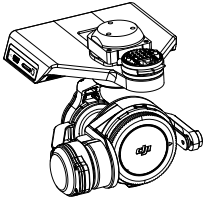

DJI MFT 15mm f/1.7 ASPH
Lens* ×1



Lens Hood* ×1



Camera Balancing Ring* ×1
(BR-Φ46-10)



512GB X5R SSD ×1

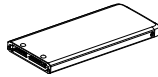

X5R READER ×1

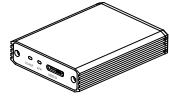

16GB Micro SD Card ×1



USB 3.0 Cable ×1



Manuals



ZENMUSE X5R In the Box

ZENMUSE X5R Disclaimer and Safety Guidelines

* The original lens, balancing ring and lens hood are only included in the Zenmuse X5R lens kit. Accessories for other supported lenses can be purchased separately on the DJI Store.

Optional Accessories

The Zenmuse X5R can be mounted on the Inspire 1 aircraft with the following accessory which is available on the DJI Store.

Inspire 1 Gimbal Mounting
Plate ×1

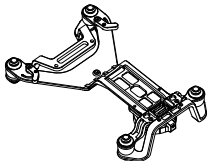

Components

Zenmuse X5R Gimbal and Camera

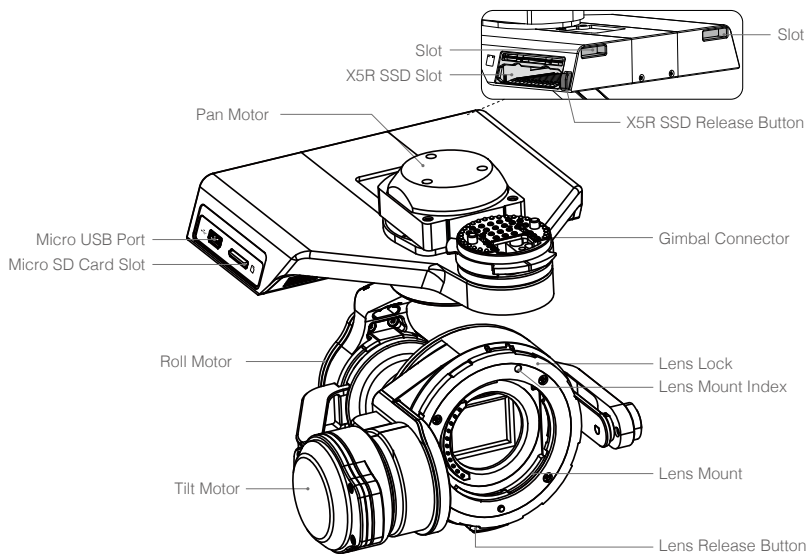

DJI MFT 15mm f/1.7 ASPH Lens

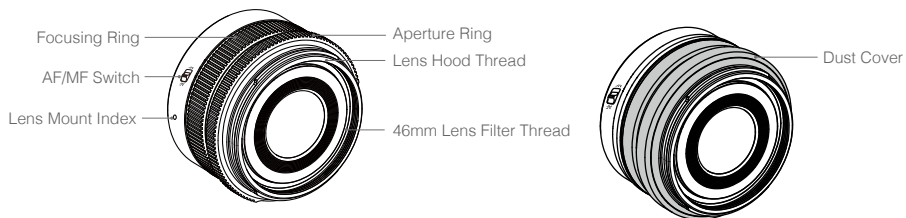

X5R Reader

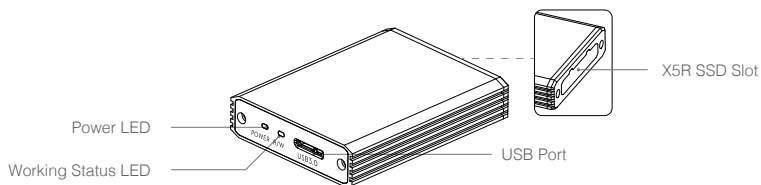

Getting Started

Read the information below before setting up your Zenmuse X5R

Supported Devices

The Zenmuse X5R can be attached to the following device, Zenmuse X5R may be compatible with other DJI devices in future.

DJI Inspire 1

Supported Lenses for the Inspire 1

The Zenmuse X5R currently supports the following lenses, and will continue to support more lenses in future.

DJI MFT 15mm f/1.7 ASPH

Panasonic Lumix G Leica DG Summilux 15mm f/1.7 ASPH

Olympus M.Zuiko Digital ED 12mm f/2.0

Olympus M.Zuiko Digital ED 17mm f/1.8

Olympus M.Zuiko Digital ED 25mm f/1.8

Olympus M.Zuiko Digital ED 45mm f/1.8 (For still photography)

Olympus M.Zuiko Digital ED 14-42mm f/3.5-5.6 EZ (For still photography)

Required Lens Accessories

The following table shows the recommended DJI Balancing Ring and filter and lens hood requirement for each lens model.

Attach either a DJI Balancing Ring or filter only. Attach a lens hood only if required. The listed Balancing Rings can be purchased on the DJI Store.

Model	DJI Balancing Ring	Filter		Lens Hood
		Thread Size	Weight	
DJI MFT 15mm f/1.7 ASPH	BR-Φ46-10	46 mm	10 g	Required
Panasonic Lumix G Leica DG Summilux 15mm f/1.7 ASPH	BR-Φ46-10	46 mm	10 g	Required
Olympus M.Zuiko Digital ED 12mm f/2.0	BR-Φ46-10	46 mm	10 g	Not required
Olympus M.Zuiko Digital ED 17mm f/1.8	BR-Φ46-33	46 mm	33 g	Not required
Olympus M.Zuiko Digital ED 25mm f/1.8	Not required	46 mm	10 g	Not required
Olympus M.Zuiko Digital ED 45mm f/1.8 (For still photography)	Not required	37 mm	14 g	Not required
Olympus M.Zuiko Digital ED 14-42mm f/3.5-5.6 EZ (For still photography)	BR-Φ37-23	37 mm	23 g	Not required

The thread size and weight of the Balancing Ring are included in the model number (i.e. BR- Φ 46-10 has a thread size of 46 mm and a weight of 10 g).

 The Balancing Ring must be installed on the camera lens when a filter is not used.

Supported Micro SD Cards

The Zenmuse X5R comes with a 16GB Micro SD card, but also supports Micro SD cards with a capacity of up to 64GB. We recommend using a UHS-1 Micro SD card to minimize the delay when reading and writing high resolution video data.

 DO NOT remove the Micro SD card from the Zenmuse X5R when it is powered on.

Supported X5R SSD

The Zenmuse X5R comes with an integrated 512GB X5R SSD for storing lossless and uncompressed footage. Note that its operating temperature is 32° to 158° F (0° to 70° C).

Installing the Camera Lens

The following steps use the DJI MFT 15mm f/1.7 ASPH as illustration of how to mount the camera lens to the camera body. Be sure to power off the battery before installation.

1. Remove the camera body cap.
2. While holding down the Lens Release Button, rotate the Lens Lock clockwise to unlock it.
3. Remove the lens cap and rear cap.

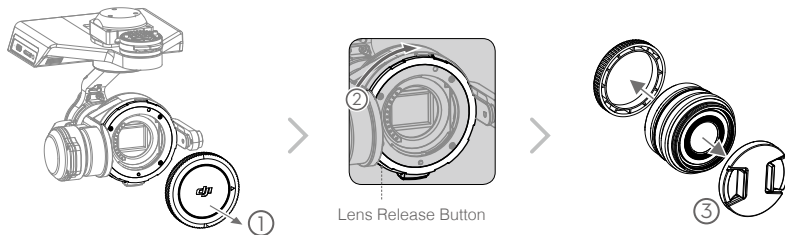

4. Align the two Lens Mount Indexes on the camera body and camera lens, and insert the camera lens into the body of the camera.
5. Rotate the camera lens clockwise until you hear a click.
6. Rotate the Lens Lock counterclockwise to lock it.
7. Mount the Balancing Ring (or a filter) and the Lens Hood.



8. Insert the Micro SD card and the X5R SSD.

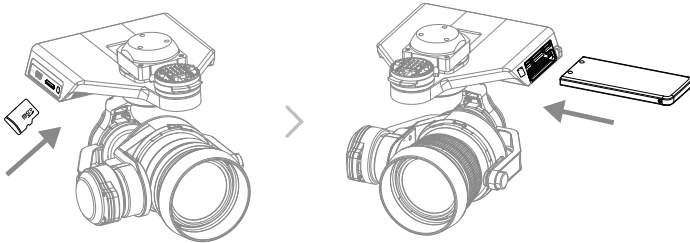

To remove the camera lens, power off the battery and then:

1. While holding down the Lens Release Button, rotate the Lens Lock clockwise to unlock it.
2. While holding down the Lens Release Button, rotate the camera lens counterclockwise to detach it.

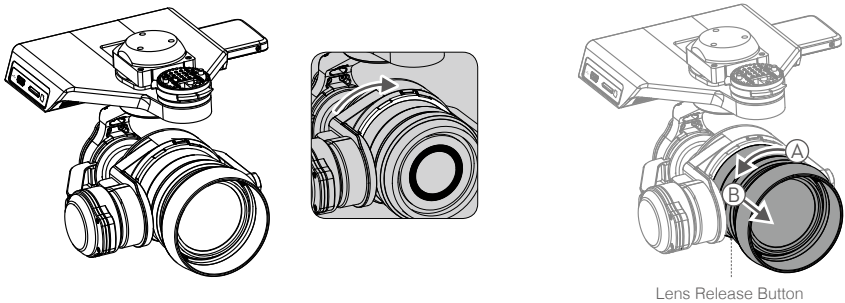

Lens Release Button

- ⚠ It is recommended to wrap a dust cover around the lens to prevent contamination. DJI produces dedicated dust covers for the DJI MFT 15mm f/1.7 ASPH and the Panasonic Lumix G Leica DG Summilux 15mm f/1.7 ASPH. Other lenses may require you to purchase a third-party dust cover.
- It is important to tighten the Lens Lock after attaching the camera lens, as this can reduce the vibrations of the lens when the aircraft is moving in flight. Always loosen the Lens Lock before attaching and detaching the camera lens.
- A filter can be installed in place of the Camera Balancing Ring. Remember to use a filter that fulfills the weight requirement.
- Some lenses must not be used with a lens hood. Be sure to check the table above for the accessory requirements for your lens.
- Be sure to set the lens to AF mode.
- Always hold down the Lens Release Button before rotating the Lens Lock to unlock it.
- Always hold down the X5R SSD Release Button before removing the X5R SSD.

Mounting the Zenmuse X5R to the Inspire 1

(Watch Video: <http://www.dji.com/product/zenmuse-x5s/info#video>)

Replace the Inspire 1 Gimbal Mounting Plate

1. Remove the two black dampers at the front.
2. Disconnect the 10-PIN cable and 8-PIN cable in order. Be careful not to damage the gimbal cables.
3. Remove the other two black dampers.

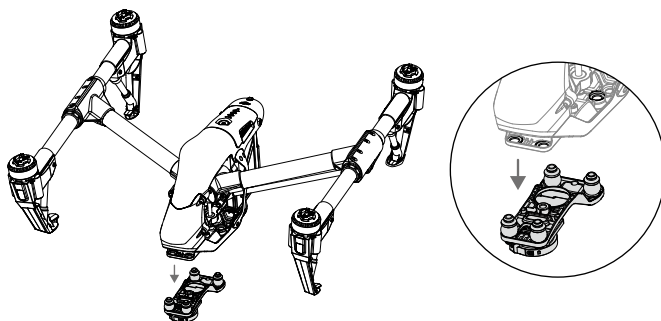

4. Attach the new gimbal mounting plate as shown below. With their flat sides facing outwards, align the rear mounting plates with the rear bracket's screw holes. Tighten the screws with a screwdriver.
5. Connect the 8-PIN cable and 10-PIN cable in order.
6. Place the front mounting bracket to the front bracket with its grooved side facing inwards. Adjust the 8-PIN cable and 10-PIN cable to avoid protrusion, and then tighten the screws.

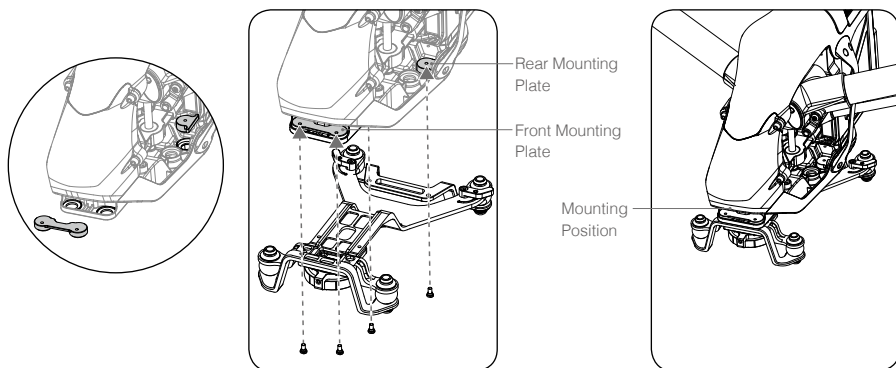

Attach the Zenmuse X5R

Power off the aircraft.

1. Rotate the Gimbal Lock to the unlocked position.
2. While aligning the white lines on the Gimbal Connector and Gimbal Lock, insert the Gimbal Connector.
3. Rotate the Gimbal Lock to the locked position.
4. Turn the two keys on the other end of the mounting plate 90 degrees into the slots.

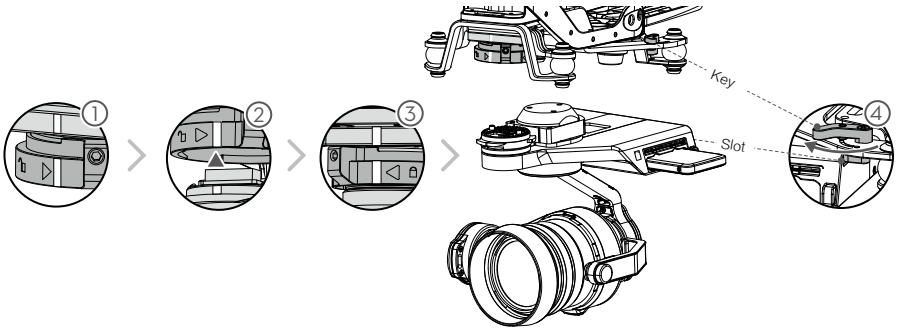

⚠ Be careful not to damage the Gimbal Connector and its metal contacts when attaching or storing the Zenmuse X5R.

Mechanical Range

The 3-axis gimbal provides an incredibly stable and mobile platform for the camera system to capture silky smooth video. The gimbal can tilt the camera up to 120 degrees and pan 320 degrees in either direction, providing 640 degrees of yaw rotation.

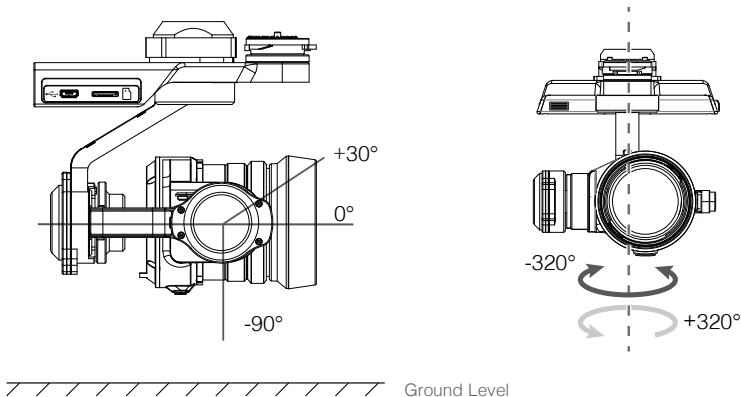

- ⚠**
- DO NOT attach or detach the Zenmuse X5R when the aircraft is powered on.
 - Take off from a flat, open area and protect the gimbal after powering up.

Operating the Camera

Camera Panel

All camera operations are done on the Camera Panel in Camera View of the DJI GO app.

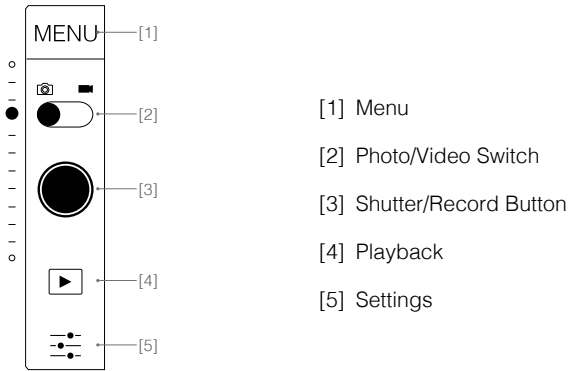

- [1] Menu
- [2] Photo/Video Switch
- [3] Shutter/Record Button
- [4] Playback
- [5] Settings

⚠ Always set the camera lens to AF mode. The focus and aperture will be controlled by the DJI GO app digitally.

Basic Shooting

Ensure the Micro SD card is inserted to enable camera operations. Photos are saved on the Micro SD card, while videos are saved on both the Micro SD card and X5R SSD.

Taking Photos

Slide the Photo/Video Switch to the position. Tap the button or the shutter button on the remote controller to take a single photo. Choose from one of the shooting modes by tapping "MENU" -> -> Photo.

1. **Burst Mode**
Take 3, 5, or 7 shots in a row.
2. **AEB (Auto Exposure Bracketing)**
Take 3 or 5 bracketed frames with $\pm 0.7\text{EV}$ steps for exposure compensation.
3. **Time-lapse**
Take photos in 5, 7, 10, 20 or 30 second intervals.

Recording Videos

Slide the Photo/Recording Switch to the position. Tap the icon or the Record Button on the remote controller to start or stop recording video.

Advanced Settings

Exposure Modes

Tap  to choose from the following exposure modes:

1. **AUTO**

The shutter speed and aperture are set automatically to obtain the correct exposure.

2. **S (Shutter Priority)**

Set your desired shutter speed, while the camera chooses the aperture automatically. This mode is ideal for freezing action, creating motion blur or low-light shots.

3. **A (Aperture Priority)**

Set your desired aperture, while the camera chooses the shutter speed automatically. This mode provides more control over depth of field and can be used to blur out backgrounds.

4. **M (Manual Exposure)**

In general, increase the ISO for low light environments, and decrease the ISO if the surroundings are very bright.

Photo Styles

Tap MENU ->  -> Style to choose from the following styles:

1. **Standard**

A general-purpose style for most scenes.

2. **Landscape**

The camera will focus on as much of the scene as possible by using a large depth of field.

3. **Soft**

Suitable for scenes with natural or soft colors.

4. **Custom**

Sharpness: -3 to +3

Contrast: -3 to +3

Saturation: -3 to +3

White Balance

Tap MENU ->  -> White Balance to choose from the following modes:

1. **Auto**

The camera adjusts the white balance automatically.

2. **Sunny / Cloudy / Incandescent / Neon**

Choose one of these modes if natural-looking colors cannot be achieved.

3. **Custom (2000K~10000K)**

Set a value between 2000K and 10000K to compensate for a specific light source.

List of Settings

Photo	
Shooting Modes	Single Shot, HDR Shot, Burst Mode (3/5/7), AEB (3/5 bracketed frames), Timed-lapse(5s/7s/10s/20s/30s)
Image Size	4:3, 16:9
Image Format	RAW, JPEG, JPEG+RAW
White Balance	Auto, Sunny, Cloudy, Incandescent, Neon, Custom (2000K~10000K)
Style	Standard, Landscape, Soft, Custom (Sharpness/Contrast/ Saturation)
Color	D-Log, D-Cinelike, None, Art, B&W, Vivid, Beach, Dream, Classic, Nostalgia
Video	
Video Size	4K (SSD RAW): 4096 × 2160 24p, (3840 × 2160) 24/30p 2.7K (SSD RAW): 2704 × 1520 24/30p 1080P (SSD RAW): 1920 × 1080 24/30/48/60p
Video Format	Micro SD: MP4/MOV (Codec: H.264) X5R SSD: CinemaDNG (Codec: Lossless JPEG)
NTSC/ PAL	PAL, NTSC
White Balance	Auto, Sunny, Cloudy, Incandescent, Neon, Custom (2000K~10000K)
Style	Standard, Landscape, Soft, Custom (Sharpness/Contrast/ Saturation)
Color	D-Log, D-Cinelike, None, Art, B&W, Vivid, Beach, Dream, Classic, Nostalgia
General	
Quick Preview	Off, 1s, 2s, 3s, 4s, 5s
Anti-Flicker	Auto, 50Hz and 60Hz
Show Grid	Off, Grid Line, Grid + Diagonal, Center Point
File Index Mode	Reset, Continuous
Others	Histograms, Video Captions, Over Exposure Warning, AF Assisted Focus, MF Assisted Focus, Lens Profile, Calibration, Reset Settings, Format SD Card, Format SSD

Note: Be sure to calibrate the camera lens in the DJI GO app for manual zoom to work properly.

Managing your Photos and Videos

Playback

Tap  in the DJI GO app or press the Playback Button on the remote controller to review photos and videos that you have captured. Press the same button again to return to capturing images.

 You can view and delete files on the Micro SD card.

Downloading your Files from Micro SD Card

Download your photo and video files to your PC via the Micro USB Port or using a Micro SD card reader.

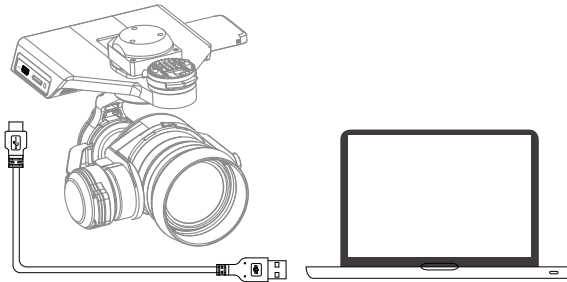

 The camera must be powered on to access the files.

DJI CineLight and your X5R SSD Files

Files on the X5R SSD must be exported with DJI CineLight*.

Installing DJI CineLight

System Requirements

- Mac OS X 10.10~10.10.5, 10.11.4 or later
- 6G of memory
- Intel i5/i7 with 4+ cores
- 1440x900 resolution
- Mac Pro, iMac and MacBook Pro recommended
- Devices supporting USB3.0 recommended
- Discrete graphics card recommended

Installation (Installer is included on the X5R SSD)

1. Plug the X5R SSD into the X5R Reader.
2. Connect the X5R Reader to your computer with a USB cable.
3. Select the "DJI" device.
4. Click to mount "DjiCineLight.dmg" in Finder.
5. Drag "CineLight.app" to /Applications/.

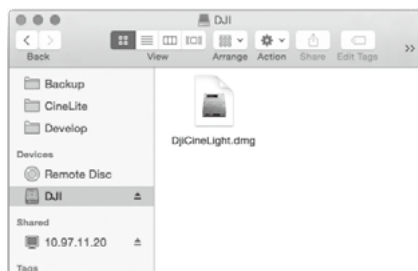

 You will be prompted if an update is available when DJI CineLight launches.

* Install the corresponding software according to your operation system.

For Windows: Install DJI Camera Exporter and refer to DJI Camera Exporter User Manual for instructions.

Accessing your Files

1. Power off the Zenmuse X5R. While holding down the X5R SSD Release Button, remove the X5R SSD.
2. Insert the X5R SSD into the X5R Reader.
3. Connect the X5 Reader to your computer with a USB cable.
4. Launch DJI CineLight.

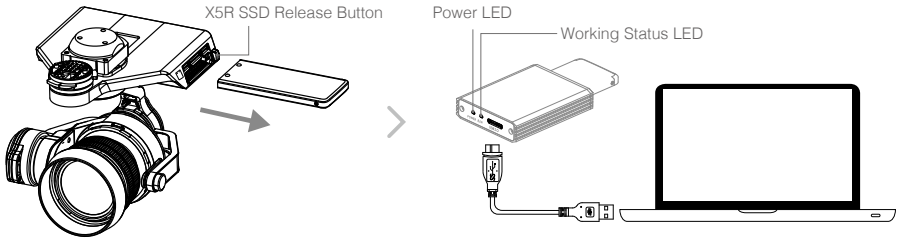

Power LED

Off X5R Reader does not have power / X5R SSD not inserted.

Solid Blue The X5R Reader is powered on and the X5R SSD is inserted correctly.

Working Status LED

Off Idle.

Blinking Blue Read and write in progress.

Post-Processing with DJI CineLight

Using DJI CineLight, you can import Adobe DNG files on the X5R SSD or your computer, add effects and enhancements, and then export them as a DNG sequence or high quality QuickTime video.



[1] Theme Switch

 : Toggle between the day and night themes.

[2] Libraries

Shows a list of connected devices (such as the X5R SSD) and your computer's local library.

Connected Devices: Displays the device's name, read-only mode, free disk space and total disk space.

Computer: Displays saved DNG sequences.

Quick Format : Right click the device name and choose "Quick Format" to reformat the connected device.

 : Indicates that the connected device is read-only and cannot be reformatted.

 Reformatting the device will cause all your files to be lost.

[3] Movie Clips

Displays all the contents in the current library (includes the name, thumbnail, and total time).

Movie clips are saved as DNG sequences but DJI Cinelight offers video playback.

 : Right click to "Export" or "Remove" the movie clip.

 A red mark will appear over the movie clip if its format is unknown.

[4] Movie Clip Tools



+ : Import movie clips to the selected library. Only DNG sequences on your computer can be imported.

- : Remove the selected movie clips.

 : Export the selected movie clips.

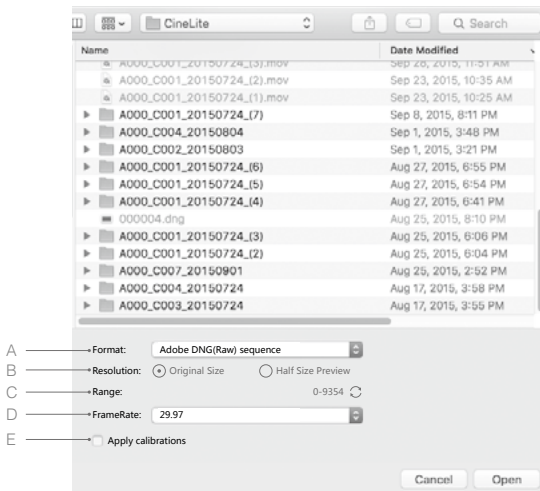



A. Export Format Options

DNG Sequence: Export the DNG sequence.

TIFF Sequence: Convert the DNG sequence to TIFF format and export.

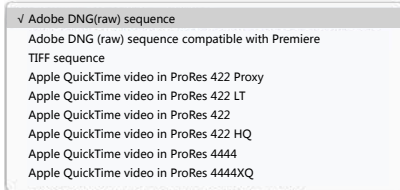
ProRes: Export the DNG sequence as a movie clip encoded in ProRes.



- B. Select "Original Size" to export the movie clip in its original resolution; select "Half Size Preview" to export the movie in half of its original resolution.
- C. Click  to synchronize the DNG sequence with the proxy files (on your Micro SD card with the same file names) to eliminate any misaligned frames. The "Range" indicates the first and last frames.
- D. Select a frame rate for the exported movie clip.
- E. Check this box to apply your effects to the exported clip. Note that this option is disabled when exporting in DNG sequence.

 You can only import and delete files in your Local Library.

[5] Cursor Mode



 : Cursor.

 : Zoom. Left click to zoom out; Alt + left click to zoom in.

 : Drag.

[6] Selected Frame

Display the frame that is currently selected.

[7] Timeline View





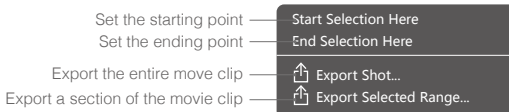

A. Click to move the frame indicator.

B. The Selection Tool allows users to select and export a section of the movie clip.



[8] Display Controls



 34%   : Zoom in or out, scale or auto fit.

Space Bar	Play/Pause
	Play previous frame
	Play next frame
Trackpad	Drag files, zoom in or zoom out.

[9] Thumbnails

[10] Playback Controls





-  : Play previous frame
-  : Play/Stop
-  : Play next frame

[11] Skip Frame Option

FRAME SKIP : Options to play the movie clip frame by frame or according to time.

[12] Timeline Actions



-  : Move to previous frame
-  : Move to next frame
-  : Export the selected frames

[13] Share

 : Share image with friends, move to folder or send by email.

[14] Layout

 : Show/hide the left, right or timeline panes.

[15] Properties

A. RGB Histogram A ————

B. Hover Pixel Color B ————

C. Image Information C ————



The screenshot shows a 'Properties' panel with an RGB histogram at the top. Below the histogram is a small image thumbnail. At the bottom, there is a table of technical data:

Size	3840 x 2160
R:	ISO 400
G:	Exposure 0.019999998
S:	Aperture f/1.8

[16] Color Calibrations

- A. Basic: Adjust the white balance, exposure and saturation.
- B. Tone Curve: Adjust up to 5 points on the tone curve.
- C. Denoise and Sharpen
Adjust the denoise and sharpening values.

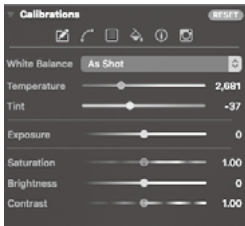

A

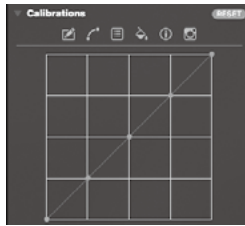

B

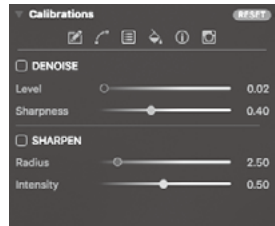

C

D. Color Management

Select the output color space.

E. Image Information

Detailed information of the movie clip.

F. Camera setting parameters when shooting.

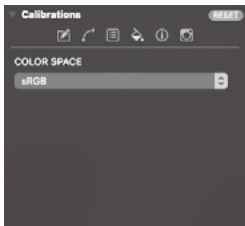

D

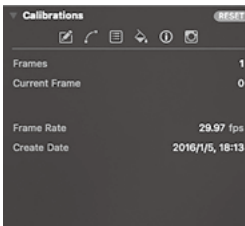

E

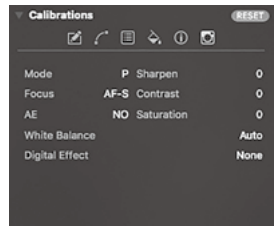

F

[17] Analysis

- A. Vector Scope
- B. RGB and YCbCr Parades

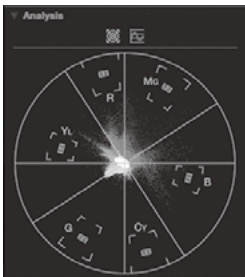

A

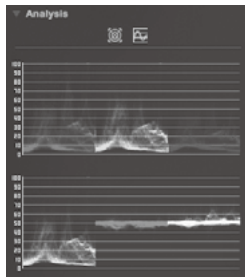

B

Appendix

Specifications

General

Name	Zenmuse X5R
Dimensions	136 (W) × 125 (H) × 131 (D) mm
Weight	Approx. 583 g (Including original lens, balancing ring, lens hood, Micro SD card, X5R SSD)
Operating Temperature	32° to 104° F (0° to 40° C)

Camera

Lens	Replaceable lens M43 mount supporting auto-focus
Supported Lenses	DJI MFT 15mm f/1.7 ASPH Panasonic Lumix G Leica DG Summilux 15mm f/1.7 ASPH Olympus M.Zuiko Digital ED 12mm f/2.0 Olympus M.Zuiko Digital ED 17mm f/1.8 Olympus M.Zuiko Digital ED 25mm f/1.8 Olympus M.Zuiko Digital ED 45mm f/1.8 (For still photography) Olympus M.Zuiko Digital ED 14-42mm f/3.5-5.6 EZ (For still photography)
Sensor	Type 4/3 CMOS sensor
Effective Pixels	16 M
Image Size	4:3, 16:9
ISO Range	Photo: 100 to 25600 Video: 100 to 6400
Electronic Shutter Speed	Photo: 8 to 1/8000 s Video: 1/25 to 1/8000 s
Field of View	DJI MFT 15mm f/1.7 ASPH 72°
Still Photography Modes	Single Shot, HDR Shot, Burst Mode (3/5/7), AEB (3/5 bracketed frames at 0.7EV bias), Timed-lapse(5s/7s/10s/20s/30s)
Video Resolution	4K (SSD RAW): 4096 × 2160 24p, (3840 × 2160) 24/30p 2.7K (SSD RAW): 2704 × 1520 24/30p 1080P (SSD RAW): 1920 × 1080 24/30/48/60p
Max Video Bitrate	Micro SD: 60 Mbps X5R SSD: 2.4 Gbps (Average: 1.7 Gbps)

Supported File Systems	Micro SD: FAT32 (<=32 GB); exFAT (>32 GB)
Photo Formats	RAW, JPEG, JPEG+RAW
VideoFormats	Micro SD: MP4/MOV (Codec: H.264) X5R SSD: CinemaDNG (Codec: Lossless JPEG)
Supported Micro SD Cards	Class 10 or UHS-1 or above Micro SD cards Max capacity of 64 GB
Supported X5R SSD	Capacity: 512 GB Dimensions: 84.25 mm × 38 mm × 6.5 mm Weight: 33 g Operating temperature: 32° - 158° F (0° - 70° C) Storage temperature: -40° - 185° F (-40° to 85° C) Humidity: 5% -95%, non-condensing
X5R READER	Dimensions: 73.6 mm × 56 mm × 15 mm Weight: 70 g Operating Temperature: 0° to 40° C
Default Lens	
Name	DJI MFT 15mm f/1.7 ASPH
Focal length	f=15 mm (35 mm format equivalent 30 mm)
Aperture type	7 diaphragm blades/circular aperture diaphragm
Maximum aperture	F1.7
Minimum aperture value	F16
Lens construction	9 elements in 7 groups (3 aspherical lenses)
In focus distance	0.2 m to ∞ (from the focus distance reference line)
Mount	Micro Four Thirds Mount
Angle of view	72°
Max. diameter	Approx. 2.26 inches (57.5 mm)
Overall length	Approx. 1.42 inches (36 mm)
Mass	115 g
Gimbal	
Angular Vibration Range	±0.02°
Mount	Detachable
Controllable Range	Pitch:-90° to +30° Pan:±320°
Max Controllable Speed	Pitch:120°/s Pan:180°/s

DJI Support:
<http://www.dji.com/support>

This content is subject to change.

Download the latest version from
<http://www.dji.com/product/zenmuse-x5s>



If you have any questions about this document, please contact DJI by sending a message to DocSupport@dji.com.