

ZENMUSE P1

User Manual v1.2

2021.04

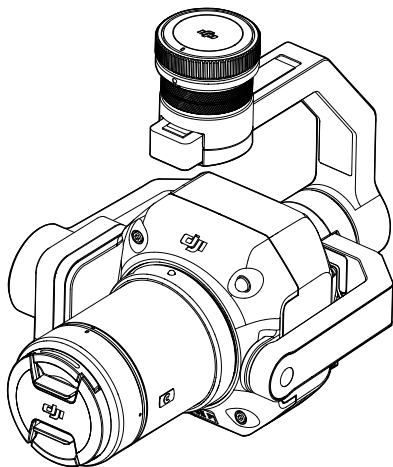

Searching for Keywords

Search for keywords such as “battery” and “install” to find a topic. If you are using Adobe Acrobat Reader to read this document, press Ctrl+F on Windows or Command+F on Mac to begin a search.

Navigating to a Topic

View a complete list of topics in the table of contents. Click on a topic to navigate to that section.

Printing this Document

This document supports high resolution printing.

Using This Manual

Legends

 Warning

 Important

 Hints and Tips

 Reference

Caution

1. When not in use, store the ZENMUSE™ P1 in the storage case and replace the desiccant packet as necessary to prevent fogging the lenses due to excessive ambient humidity. If the lenses fog up, the water vapor will usually dissipate after powering on the device for a while. It is recommended to store the P1 in an environment with a relative humidity of less than 40% and temperature of $20\pm 5^{\circ}\text{C}$.
2. DO NOT place the product under direct sunlight, in areas with poor ventilation, or near a heat source such as a heater.
3. DO NOT repeatedly power the product on or off. After powering off, wait at least 30 seconds before powering back on. Otherwise, the product life will be affected.
4. Under stable laboratory conditions, the P1 achieves an IP4X protection rating by IEC60529 standards. The protection rating is not permanent, however, and may reduce over an extended period.
5. Make sure there is no liquid on the surface or in the port of the gimbal.
6. Make sure the gimbal is securely installed on the aircraft and the SD card slot cover is closed properly.
7. Make sure the surface of the gimbal is dry before opening the SD card slot cover.
8. DO NOT remove or insert the SD card when taking a photo or recording a video.
9. DO NOT touch the surface of the lens with your hand. Be careful to avoid scratching the surface of the lens with sharp objects. Otherwise, the quality of images may be affected.
10. Clean the surface of the camera lens with a soft, dry, clean cloth. DO NOT use alkaline detergents.
11. DO NOT press the lens release button while attaching the lens. DO NOT repeatedly disassemble and assemble the lens unless necessary.
12. DO NOT plug or unplug the lens after powering on.
13. DO NOT plug or unplug the P1 after powering on. Press the power button on the aircraft to power off instead of removing the P1 directly from the aircraft.
14. Make sure to use a storage case when transporting the P1 as the gimbal is a precision instrument.

Contents

Using This Manual	3
Legends	3
Caution	3
Product Profile	6
Introduction	6
Installation	7
Supported Aircraft	7
Supported Lenses	7
Installing a Camera Lens	7
Installing on the Aircraft	8
Gimbal Rotating Range	9
Compatible Lenses	10
MTF	10
Lens Specifications	11
Mounting Filters/Protector	12
Remote Controller Controls	13
DJI Pilot App Controls	14
Basic Features	14
Camera Mode Settings	15
Enterprise Applications	16
Smart Oblique Description	16
Nap-Of-The-Object Photogrammetry Description	17
Flight Mission Usage	18
Preparation	18
Mapping Mission	18
Smart Oblique	18
Terrain Follow	19

Oblique Mission	20
Linear Flight Mission	21
Waypoint Flight	21
Data Storage	22
Photo File	22
Image Log File	23
GNSS Observation File	24
Maintenance	25
Exporting Log	25
Firmware Update	25
Specifications	26

Product Profile

Introduction

The Zenmuse P1 integrates a 45MP full-frame sensor, a global mechanical shutter, and an interchangeable fixed-focus DJI DL Lens on a 3-axis stabilized gimbal. Designed to be used with compatible DJI aircraft and DJI TERRA™ for photogrammetry flight missions, the P1 takes efficiency and accuracy to a whole new level.

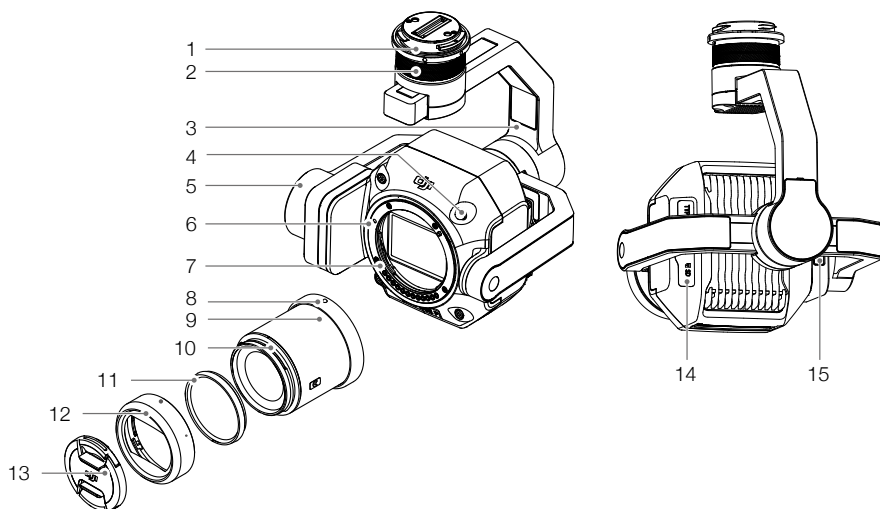

- | | |
|-------------------------|------------------------------|
| 1. Gimbal Connector | 9. Lens |
| 2. Pan Motor | 10. Lens Hood Mounting Index |
| 3. Roll Motor | 11. Balancing Ring |
| 4. Lens Release Button* | 12. Lens Hood |
| 5. Tilt Motor | 13. Lens Cap |
| 6. Lens Mounting Index | 14. SD Card Slot |
| 7. Lens Mount | 15. microSD Card Slot |
| 8. Lens Mounting Index | |

* DO NOT press the lens release button while attaching the lens.

Installation

Supported Aircraft

MATRICE™ 300 RTK

Supported Lenses

The P1 currently supports the following lenses when used with the DJI DL-Mount and will support additional lenses in future.

DJI DL 24mm F2.8 LS ASPH Lens

DJI DL 35mm F2.8 LS ASPH Lens

DJI DL 50mm F2.8 LS ASPH Lens

☀️ The DJI DL 35mm F2.8 LS ASPH Lens is included with the Zenmuse P1. Contact local dealers for more information on how to purchase other compatible lenses. Refer to Specifications to check supported lens models.

⚠️ Only use supported lenses. Otherwise, the accuracy of surveying and mapping may be affected.

Installing a Camera Lens

- ⚠️
- DO NOT repeatedly disassemble and assemble the lens unless necessary.
 - DO NOT attach or remove the lens after powering on.

1. Remove the camera body cap.
2. Remove the lens cap and rear cap.

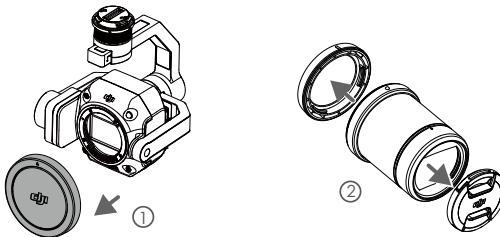

3. Align the two lens mount indexes on the camera body and camera lens and insert the camera lens into the camera body.
4. Rotate the camera lens clockwise until it clicks into place.

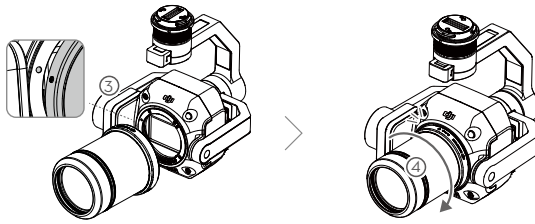

5. Rotate the camera lens counter-clockwise after mounting the lens to make sure the lens is firmly attached.

- ⚠ • DO NOT press the lens release button while attaching the lens.
- Mount the camera lens with the lens mount facing downward to prevent dust from entering the sensor. Otherwise, the performance may be negatively affected.

Installing on the Aircraft

1. Remove the gimbal cap.
2. Press the button on the aircraft to detach the gimbal and camera. Rotate the gimbal cap on the aircraft to remove.
3. Align the white dot on the gimbal with the red dot on the aircraft and insert the gimbal.
4. Rotate the gimbal lock to the locked position by aligning the red dots.

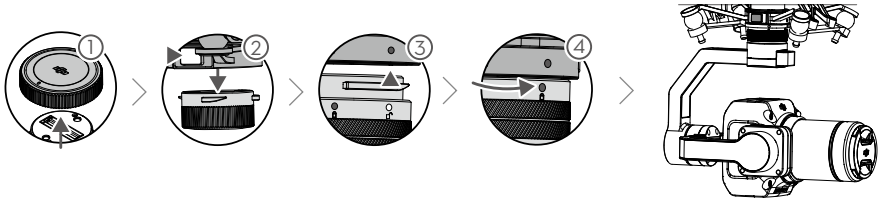

- ⚠ • Make sure the gimbal connector on the aircraft is positioned correctly when mounting. Otherwise, the camera cannot be mounted.
- Remove the P1 by pressing the button on the aircraft to detach the gimbal and camera.
 - Place the P1 in the storage case with the lens attached. It is not recommended to repeatedly disassemble and assemble the lens.
 - Only remove the P1 after powering off the aircraft.
 - Detach the gimbal from the aircraft during transportation or storage. Otherwise, the service life of the damper balls may be shortened or they may even be damaged.
 - Before takeoff, make sure that the SD card cover is closed properly. Otherwise, it may obstruct the gimbal arm from moving and cause the motor to overload.

Gimbal Rotating Range

The 3-axis gimbal provides a stable and mobile platform for the camera system to capture smooth images and videos. The tilt, pan, and roll ranges are listed below.

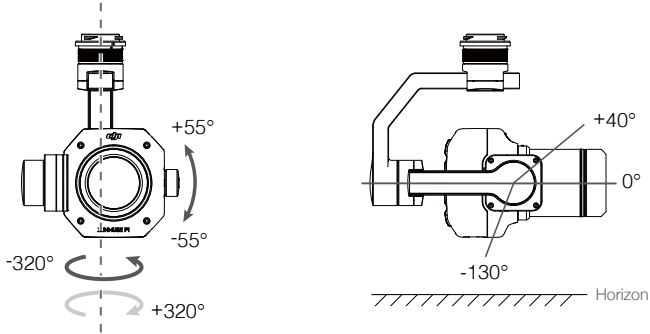

- Take off from flat and open ground. DO NOT block or touch the gimbal after powering on.
 - Make sure that the SD card cover is closed properly. Otherwise, it may obstruct the rotation of the gimbal.
-

Compatible Lenses

DJI DL Lenses are compatible with the DJI DL-Mount, which has a diameter of 58 mm. The focal lengths of the three DJI DL lenses are 24mm, 35mm, and 50mm. The built-in mechanical global shutter supports an exposure time of up to 1/2000 s.

MTF

An MTF (Modulation Transfer Function) chart is used to measure the ability of a lens to reproduce contrast and resolve details. Low spatial frequencies reflect overall contrast and high spatial frequencies reflect detail resolution.

DJI DL 24mm F2.8 LS ASPH Lens

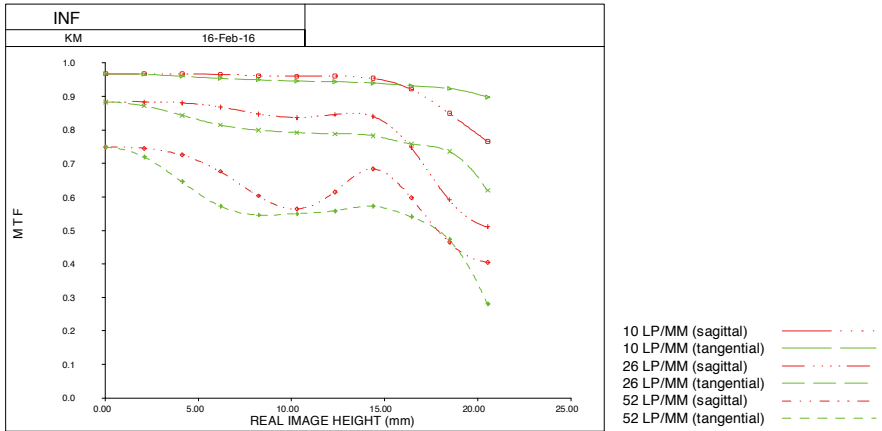

DJI DL 35mm F2.8 LS ASPH Lens

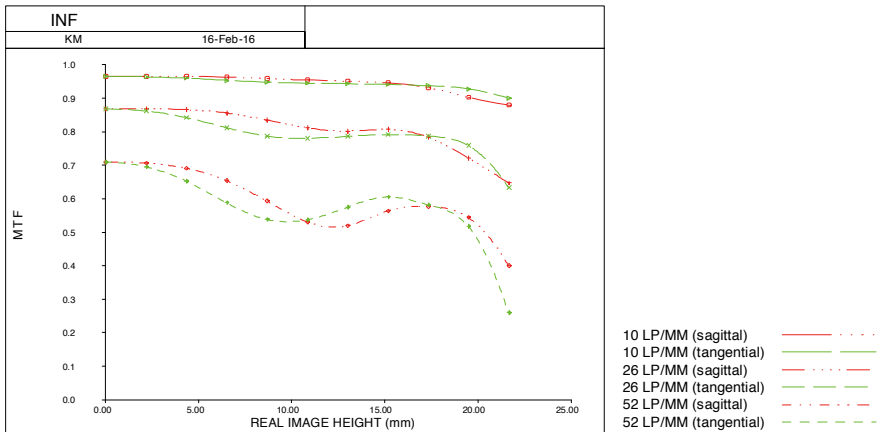

DJI DL 50mm F2.8 LS ASPH Lens

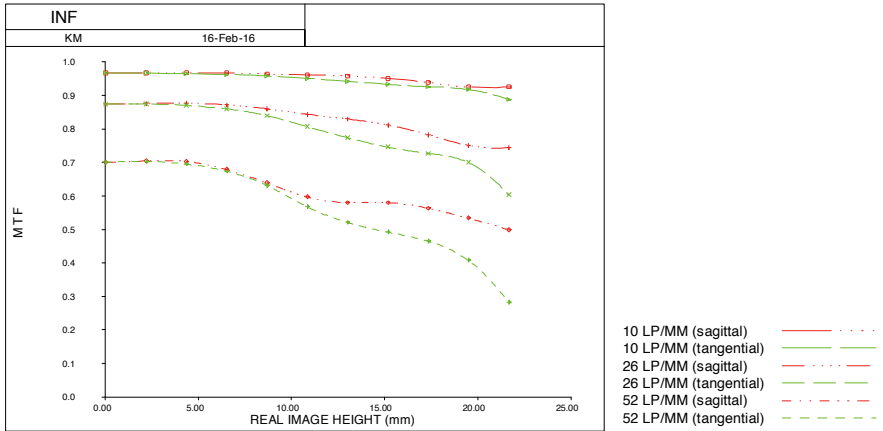

Lens Specifications

Lens	DJI DL 24mm F2.8 LS ASPH Lens	DJI DL 35mm F2.8 LS ASPH Lens	DJI DL 50mm F2.8 LS ASPH Lens
Focal Length	24 mm	35 mm	50 mm
Aperture Range	f/2.8 - f/16	f/2.8 - f/16	f/2.8 - f/16
FOV*	82.440° (72.180°×51.800°)	63.000° (53.630°×36.960°)	46.200° (38.800°×26.270°)
Close Focus	0.65 m	0.85 m	0.93 m
Filter Diameter	46 mm	46 mm	46 mm
Elements/Groups/ASPH	9/8/3	9/8/3	9/7/2
Barrel Dimensions (diameter×length)	Ø 55.0×71.2 mm (incl. lens hood)	Ø 55.0×71.2 mm (incl. lens hood)	Ø 55.0×71.2 mm (incl. lens hood)
Weight	Approx. 178 g	Approx. 180 g	Approx. 182 g
Relationship between ground sample distance (GSD) and shooting distance (L) **	GSD=L/55	GSD=L/80	GSD=L/114

* The sensor size is 43.3 mm (36.045 mm×24.024 mm), and the frame ratio is 3:2.

** GSD: unit in cm/pixel, L: unit in m.

Mounting Filters/Protector

1. Rotate and remove the lens hood.
2. Rotate and remove the balancing ring.
3. Mount the new filter or protector and the lens hood. When mounting the lens hood, first align the small red dot on the lens hood with the red dot on the lens and rotate the lens hood to align the large red dot with the dot on the lens.

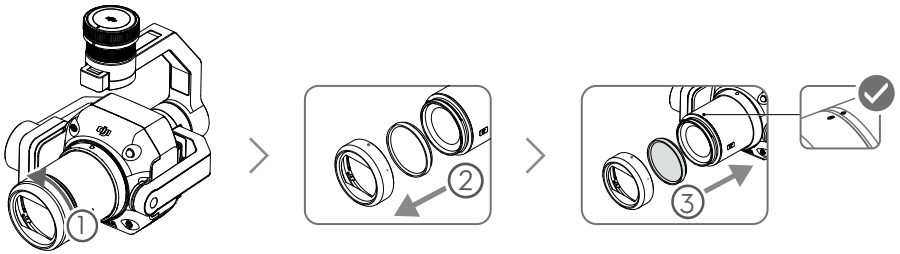

4. Do not mount the lens hood if two lens filters are attached. Note that the amount of lens flare will increase without the lens hood.

Remote Controller Controls

The Matrice 300 RTK remote controller is used as an example below. Adjust the tilt of the gimbal using the left dial and adjust the pan using the right dial. Press the shutter button or record button to take photos or record video. Toggle the 5D button to adjust the EV value. The customizable C1 button can be used to recenter the gimbal and the customizable C2 button can be used to switch between the main and auxiliary screen.

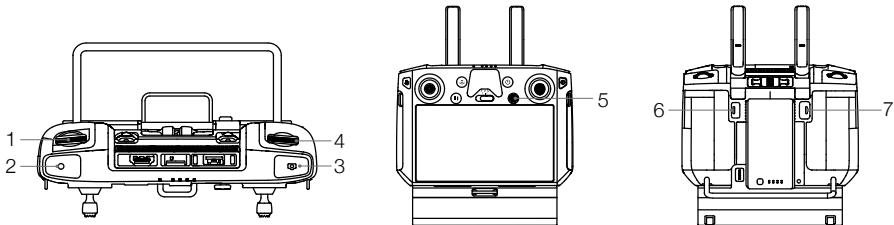

- 1. Left Dial**
Turn to adjust the tilt of the gimbal.
- 2. Record Button**
Press to start or stop recording video.
- 3. Shutter Button**
Press to take a photo. The photo mode can be set to single or interval in DJI Pilot. Single photos can also be taken during video recording.
- 4. Right Dial**
Turn to adjust the pan of the gimbal.
- 5. 5D Button**
The default functions of the 5D button are listed below and can be customized in DJI Pilot.
Left: Decrease EV value
Right: Increase EV value
- 6. Customizable Button C2**
The default function is to switch between the main and auxiliary screen. The function for this button can be customized in DJI Pilot.
- 7. Customizable Button C1**
The default function is to recenter the gimbal. The function for this button can be customized in DJI Pilot.

DJI Pilot App Controls

The touchscreen interface can be used to capture photos, record videos, and view playback. Professional photography configurations are also available.

Basic Features



The interface may need to be updated. Make sure to update to the latest version.

- 1. Live HD Video**
Displays the current camera view.
- 2. Camera Parameters**
Displays the current camera parameters.
- 3. Focus Mode**
Tap to switch between manual and auto focus.
- 4. Auto Exposure Lock**
Tap to lock the exposure value.
- 5. Camera Settings**
Tap to enter the photo and video settings. Tap to configure photo settings such as photo mode and image format. Tap to configure video settings such as video size and format. Tap to configure the grid. The settings may vary according to the camera model.
- 6. Gimbal Slider**
Displays the tilt angle of the gimbal.
- 7. Recording Mode (Shutter/Video Record)**
Tap to switch between photo and video recording modes.

8. Manual Focus Slider

Tap to adjust the position of the camera focus.

9. Shooting Button (Shutter/Video Record)

Tap to shoot photos or start or stop recording.

10. Playback

Tap to enter and preview photos and videos as soon as they are captured.

11. Parameter Settings

Tap to set ISO, shutter, exposure values, and other parameters.

Camera Mode Settings

Auto: The shutter speed, aperture, and ISO are set automatically to obtain the correct exposure according to the surroundings.

A: Set the aperture. The shutter speed and ISO are set automatically according to the surroundings.

S: Set the shutter speed. The aperture and ISO are set automatically according to the surroundings.

M: Set the aperture, shutter speed, and ISO.

M+Auto ISO (recommended): Set the shutter speed and aperture. The ISO is automatically set according to the surroundings.



It is recommended to set the shutter speed as faster than 1/500 s.

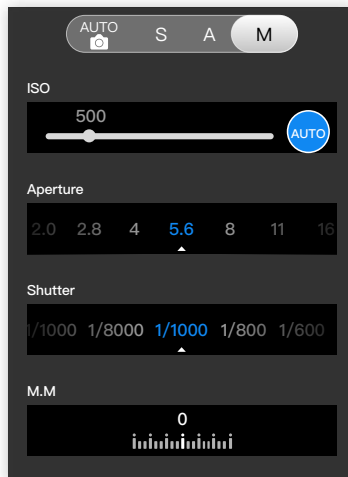

Enterprise Applications

Smart Oblique Description

When Smart Oblique is enabled, a flight route in the flight area will be automatically generated once the mapping area is set. The P1 takes an orthophoto and an oblique photo in a single flight by moving the gimbal to different positions. The P1 will only take photos relating to reconstruction when at the edge of the mapping area, which reduces the number of photos taken and greatly improves post-processing efficiency.

During a Smart Oblique flight, the position of the gimbal and number of photos taken depend on the area mapped by the user and may vary in different segments of the flight route.

- A. The aircraft will automatically adjust the flight speed according to the number of photos required to ensure the most efficient operation possible.

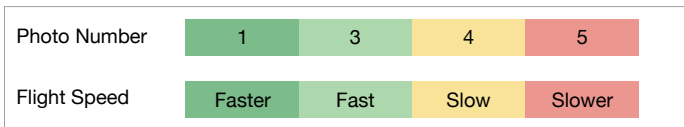

- B. During a Smart Oblique flight, each flight route segment is composed of a shooting sequence and each photo in the sequence can be taken in a different direction.



- C. The flight area will vary depending on the mapping area, flight height, and gimbal pitch. The flight area will also vary when the mapping area is the same, but the flight height or gimbal pitch vary. See below for more information.

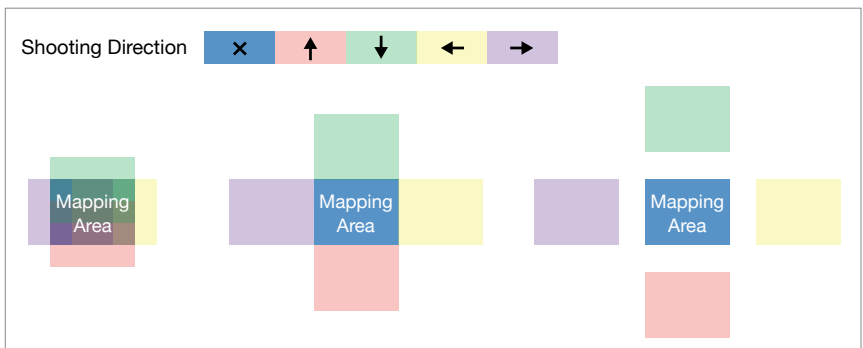

 Only supported when using Matrice 300 RTK and Zenmuse P1 together. Make sure Smart Oblique is enabled in the mapping mission settings.

Nap-Of-The-Object Photogrammetry Description

For nap-of-the-object photogrammetry, it is recommended to set the camera to M mode and to calibrate the infinity focus point. Adjust the shutter speed and aperture, enable auto ISO, and set the metering mode to global metering.

Aperture Setting

To obtain high-resolution photos when lighting conditions are good, users can select a smaller aperture that shortens the hyperfocal distance and reduces the GSD.

Choose the largest possible aperture that meets the required resolution to obtain the largest possible luminous flux. If lighting conditions are good, use a faster shutter speed to avoid motion blur.

It is recommended to use an aperture of f/5.6-f/11.

Aperture Parameters

Aperture Range	24mm Lens		35mm Lens		50mm Lens	
	Minimum shooting distance between P1 and the object (m)	GSD (mm/pixel)	Minimum shooting distance between P1 and the object (m)	GSD (mm/pixel)	Minimum shooting distance between P1 and the object (m)	GSD (mm/pixel)
2.8	23.4	4.2	49.7	6	101	8.9
5.6	11.7	2.1	25	3	50	4.4
8	8.2	1.5	17.5	2	35	3.1
11	5.9	1.06	12.6	1.6	25.8	2.3
16	4.1	0.75	8.7	1	17.8	1.5



Flight Mission Usage

The P1 supports Mapping, Oblique, Linear Flight, and Waypoint missions. Smart Oblique and Terrain Follow can be enabled in Mapping mission.

Preparation

1. Make sure the P1 is installed correctly on the aircraft and that the aircraft and remote controller are linked after powering on.
2. Go to camera view in DJI Pilot, select ●●●, then RTK, choose the RTK service type, and make sure that the status of the RTK positioning and heading are both FIX.
3. Set the RTH altitude, Home Point, and Failsafe behavior based on the obstacles within the flight route. When flying near a GEO zone, it is recommended to set the flight altitude at least 5 meters below the altitude limit of the GEO zone.

Mapping Mission

1. Enter the mission flight screen in DJI Pilot, select Create a Route, and  to choose a Mapping mission. Tap and drag on the map to adjust the area that will be scanned and tap + to add a waypoint.
2. Edit parameters:
 - A. Select Zenmuse P1 (35mm) as the camera type according to the lens type. A 35mm lens is used as an example.
 - B. Set the altitude, takeoff speed, route speed, the action upon completion, and enable elevation optimization.
 - C. In Advanced Settings, set the side overlap ratio, forward overlap ratio, course angle, margin, and photo mode.
 - D. In Payload Settings, set the focus mode and dewarping.During an orthophoto operation, it is recommended to adjust the route speed to the maximum value and enable elevation optimization. Set the focus mode to First Waypoint Autofocus and disable dewarping.
3. Select  to save the mission and select  to upload and execute the flight mission.
4. Power off the aircraft after the mission is completed and remove the SD card from the P1. Connect it to a computer and check photos and files.

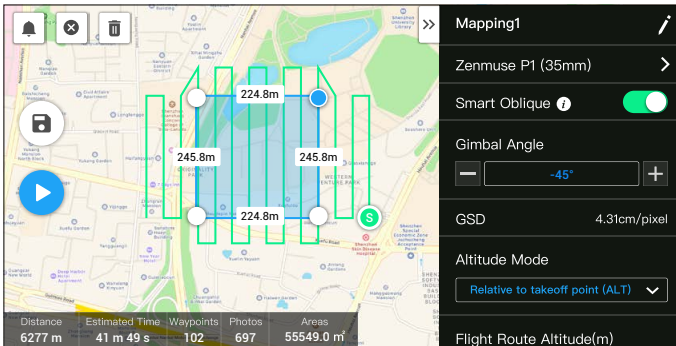

Smart Oblique

Smart Oblique can be enabled in Mapping mission.



1. Enter the mission flight screen in DJI Pilot, select Create a Route, and  to choose a Mapping mission. Tap and drag on the map to adjust the area that will be scanned and tap + to add a waypoint.
2. Edit parameters:
 - A. Select the camera type.
 - B. Enable Smart Oblique.
 - C. Set the gimbal angle, display altitude/height, takeoff point to target surface, takeoff speed, and the action upon completion.
 - D. In Advanced Settings, set the side overlap ratio, forward overlap ratio, and course angle.
 - E. In Payload Settings, set the focus mode and dewarping.

During a Smart Oblique flight, the aircraft will fly as efficiently as possible by adjusting the flight speed according to the number of photos taken in each flight route segment.

It is recommended to set the gimbal angle to -45° , set the mapping area focus mode to First Waypoint Autofocus, disable dewarping, and select the photo format as JPEG.
3. Select  to save the mission and select  to upload and execute the flight mission.
4. Power off the aircraft after the mission is complete and remove the SD card from the P1. Connect it to a computer and check photos and files.

Mapping Area Focus Mode

In Payload Settings, set the mapping area focus mode to First Waypoint Autofocus or Calibrated Infinity Focus.

It is recommended to set the mapping area focus mode to First Waypoint Autofocus.

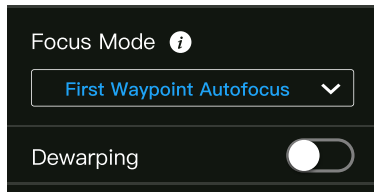

Terrain Follow

To perform a precise Terrain Follow flight, enable Terrain Follow in Mapping mission and import the DSM file including the altitude information.

Preparing Files

The DSM files of the measurement area can be obtained through the following two methods:

- A. Collect the 2D data of the mapping area and perform a 2D reconstruction through DJI Terra by selecting Fruit Tree. A .tif file will be generated and can be imported to the microSD card of the remote controller.
- B. Download the terrain mapping data from a geobrowser and import to the microSD card of the remote controller.



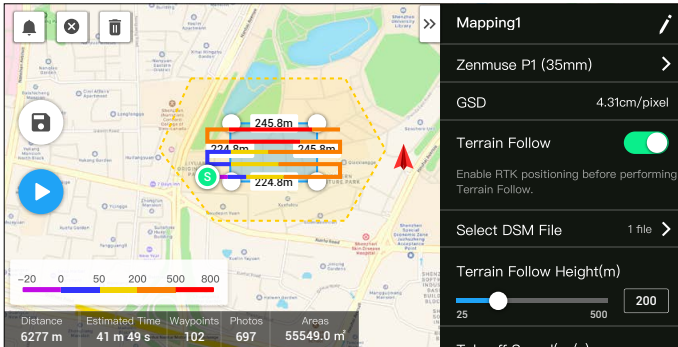

Make sure that the DSM file is a geographic coordinate system file, and not a projected coordinate system file. Otherwise, the imported file may not be recognized. It is recommended that the resolution of the imported file should be no more than 10 meters.

Importing Files





1. Enable Terrain Follow in Mapping mission.
2. Tap Select DSM File. Tap +, select and import the file from the microSD card of the remote controller, and wait for the file to be imported.
3. The imported files will be displayed in the list.

Planning a Flight Route

1. Enable Terrain Follow in Mapping mission and select a file from the Select DSM File screen.
2. Edit the parameters in Mapping mission:
 - A. Set the terrain follow height.
 - B. Set the takeoff speed, route speed, and action upon completion.
 - C. In Advanced Settings, set the side overlap ratio, forward overlap ratio, course angle, margin, and photo mode.
 - D. In Payload Settings, set the mapping area focus mode and enable dewarping.
It is recommended to set the mapping area focus mode to First Waypoint Autofocus.
3. Select  to save the mission and select  to upload and execute the flight mission.
4. Power off the aircraft after the mission is complete and remove the SD card from the P1. Connect it to a computer and check photos and files.

Oblique Mission



1. Enter the mission flight screen in DJI Pilot, select Create a Route or import a KML file, and then select  to choose an Oblique mission. Tap and drag on the map to adjust the area that will be surveyed and tap + to add a waypoint.
2. Edit the parameters:
 - A. Select the camera type.
 - B. Set the gimbal pitch (oblique), altitude, takeoff speed, route speed, and action upon completion.
 - C. In Advanced Settings, set the side overlap ratio, forward overlap ratio, side overlap ratio (oblique), forward overlap ratio (oblique), course angle margin, and photo mode.

3. Select  to save the mission and select  to upload and execute the flight mission.
4. Power off the aircraft after the mission is complete and remove the SD card from the P1. Connect it to a computer and check photos and files.

Linear Flight Mission

1. Enter the mission flight screen in DJI Pilot, select Create a Route, and then  to choose a Linear Flight mission. Tap and drag on the map to adjust the area that will be surveyed and tap + to add a waypoint.
2. Edit the parameters:
 - A. Select the camera type.
 - B. Edit the parameters for a Linear Flight mission or Waypoint mission.
 - a. Linear Flight mission: Set the single route, the left/right extensions, adjust the left/right extension length, and flight band cutting distance.
 - b. Waypoint mission: Set the altitude, takeoff speed, route speed, boundary optimization, photo mode, action upon completion, and whether to include the center line. In Advanced Settings, set the side overlap ratio and forward overlap ratio.

It is recommended to set the forward overlap ratio to 80% and side overlap ratio to 70%.

3. Select  to save the mission and select  to upload and execute the flight mission.
4. Power off the aircraft after the mission is complete and remove the SD card from the P1. Connect it to a computer and check photos and files.

Waypoint Flight

Read the Mission Flight section in the Matrice 300 RTK User Manual for more information about waypoint flight.

Data Storage

Photo File

XMP Data List

Refer to this list to check the descriptions for the photo file field.

Field	Field Description
ModifyDate	Time photo was modified
CreateDate	Time photo was created
Make	Manufacturer
Model	Product model
Format	Photo format
Version	Version
GpsStatus	GPS status
AltitudeType	Elevation type
GpsLatitude	GPS latitude when photo was taken
GpsLongitude	GPS longitude when photo was taken
AbsoluteAltitude	Absolute altitude (geodetic height) when photo was taken
RelativeAltitude	Relative altitude (relative to the height of takeoff point) when photo was taken
GimbalRollDegree	Gimbal roll angle when photo was taken
GimbalYawDegree	Gimbal yaw angle when photo was taken
GimbalPitchDegree	Gimbal pitch angle when photo was taken
FlightRollDegree	Aircraft roll angle when photo was taken
FlightYawDegree	Aircraft yaw angle when photo was taken
FlightPitchDegree	Aircraft pitch angle when photo was taken
FlightXSpeed	Flight speed when photo was taken
FlightYSpeed	Flight speed in the east direction when photo was taken
FlightZSpeed	Flight speed in the elevation direction when photo was taken
CamReverse	Whether the camera is upside down or not
RtkFlag	RTK status: 0 - Failed to position 16 - Single point positioning (meter-level accuracy) 34 - Floating point solution positioning (decimeter level accuracy) 50 - Fixed solution positioning (centimeter-level accuracy)
RtkStdLon	RTK positioning standard longitude deviation
RtkStdLat	RTK positioning standard latitude deviation
RtkStdHgt	RTK positioning standard elevation deviation
RtkDiffAge	RTK difference age (correction age)
SurveyingMode	Whether the photo is suitable for mapping operation or not: 0 - Not recommended as the accuracy cannot be guaranteed 1 - Recommended as the accuracy can be guaranteed

DewarpFlag	Whether the camera parameters have been dewarped or not: 0 - Not dewarped 1 - Dewarped
DewarpData	Camera parameters for dewarping (the calibration file must be imported and calibrated in DJI Terra for the data to be generated): Parameter sequence - fx, fy, cx, cy, k1, k2, p1, p2, k3 fx, fy - Calibrated focal length (unit: pixel) cx, cy - Calibrated optical center position (unit: pixel, origin point: photo center) k1, k2, p1, p2, k3 - Radial and tangential distortion parameters
UTCAtExposure	UTC when the camera is exposed.
ShutterType	Shutter type
ShutterCount	Shutter count used
CameraSerialNumber	Camera serial number
LensSerialNumber	Lens serial number
DroneModel	Aircraft model
DroneSerialNumber	Aircraft serial number

Image Log File

Open an image log file with the extension .MRK to view the data below.

The screenshot shows a file explorer window with several image log files. Below the files, a preview window displays a table of image log data. The table has 7 columns: Line number, Time (s), X (m), Y (m), Z (m), Roll (°), Pitch (°), and Yaw (°). The data shows a sequence of 27 lines of image log data.

Line	Time (s)	X (m)	Y (m)	Z (m)	Roll (°)	Pitch (°)	Yaw (°)
1	450011.165618	228763	17, N	12, E	184		
2	450016.648938	228761	12, N	-2, E	193		
3	450022.155587	228761	13, N	-5, E	194		
4	450027.646998	228761	8, N	5, E	192		
5	450033.167513	228761	12, N	-3, E	193		
6	450038.683328	228761	15, N	8, E	194		
7	450044.182455	228761	8, N	-5, E	192		
8	450049.655814	228761	7, N	8, E	193		
9	450055.144456	228761	15, N	-2, E	194		
10	450060.667819	228761	15, N	7, E	194		
11	450066.149948	228761	8, N	-8, E	193		
12	450071.642898	228761	18, N	8, E	194		
13	450077.188745	228761	8, N	-4, E	194		
14	450082.686215	228761	5, N	-83, E	176		
15	450088.173255	228761	13, N	-43, E	189		
16	450093.658288	228761	13, N	-43, E	189		
17	450099.158493	228761	11, N	-48, E	189		
18	450104.641944	228761	7, N	-58, E	187		
19	450110.158771	228761	11, N	-31, E	189		
20	450115.658455	228761	6, N	-58, E	187		
21	450121.143176	228761	8, N	-58, E	187		
22	450126.652854	228761	8, N	-58, E	187		
23	450132.162957	228761	8, N	-58, E	187		
24	450137.644187	228761	12, N	-58, E	189		
25	450143.144854	228761	3, N	-51, E	187		
26	450148.642988	228761	6, N	-58, E	187		
27	450154.162825	228761	12, N	-58, E	187		

01	37124484	37124484	37124484	-480.0	307.0	307.0	307.0	22.902811219	1.045	1.13	7.040114584	1.045	1.045	7.011	5.513	0.012427	0.018366	0.013132	30.0
02	37124484	37124484	37124484	-482.0	306.0	306.0	306.0	22.902812049	1.045	1.13	7.040115744	1.045	1.045	7.019	5.513	0.012732	0.018474	0.013276	30.0
03	37124487	37124487	37124487	-487.0	312.0	312.0	312.0	22.902813074	1.045	1.13	7.040116924	1.045	1.045	7.024	5.513	0.013052	0.018571	0.013397	30.0
04	37124489	37124487	37124487	-480.0	312.0	312.0	312.0	22.902813046	1.045	1.13	7.040104271	1.045	1.045	7.023	5.513	0.012393	0.018029	0.013040	30.0
05	37124489	37124484	37124484	-482.0	312.0	312.0	312.0	22.902814046	1.045	1.13	7.039893393	1.045	1.045	7.024	5.513	0.012738	0.018466	0.013267	30.0
06	37124489	37124487	37124487	-487.0	312.0	312.0	312.0	22.902814022	1.045	1.13	7.039893393	1.045	1.045	7.024	5.513	0.013057	0.018462	0.013261	30.0
07	37124491	37124487	37124487	-480.0	312.0	312.0	312.0	22.902814087	1.045	1.13	7.039894294	1.045	1.045	7.024	5.513	0.012393	0.018029	0.013040	30.0
08	37124492	37124487	37124487	-480.0	312.0	312.0	312.0	22.902814249	1.045	1.13	7.039894819	1.045	1.045	7.024	5.513	0.012738	0.018466	0.013267	30.0
09	37124494	37124487	37124487	-484.0	312.0	312.0	312.0	22.902815049	1.045	1.13	7.039895344	1.045	1.045	7.024	5.513	0.012498	0.018179	0.013149	30.0
10	37124494	37124484	37124484	-484.0	312.0	312.0	312.0	22.902815025	1.045	1.13	7.039895344	1.045	1.045	7.024	5.513	0.012498	0.018179	0.013149	30.0
11	37124494	37124489	37124489	-484.0	312.0	312.0	312.0	22.902815087	1.045	1.13	7.039895393	1.045	1.045	7.024	5.513	0.013057	0.018466	0.013267	30.0
12	37124497	37124489	37124489	-489.0	312.0	312.0	312.0	22.902816049	1.045	1.13	7.039896394	1.045	1.045	7.024	5.513	0.013057	0.018466	0.013267	30.0
13	37124497	37124484	37124484	-489.0	312.0	312.0	312.0	22.902816025	1.045	1.13	7.039896394	1.045	1.045	7.024	5.513	0.012498	0.018179	0.013149	30.0
14	37124499	37124484	37124484	-480.0	307.0	307.0	307.0	22.902817049	1.045	1.13	7.039897394	1.045	1.045	7.024	5.513	0.012498	0.018179	0.013149	30.0
15	37124499	37124489	37124489	-480.0	307.0	307.0	307.0	22.902817025	1.045	1.13	7.039897394	1.045	1.045	7.024	5.513	0.012498	0.018179	0.013149	30.0
16	37124499	37124484	37124484	-480.0	307.0	307.0	307.0	22.902817087	1.045	1.13	7.039897394	1.045	1.045	7.024	5.513	0.012498	0.018179	0.013149	30.0
17	37124499	37124489	37124489	-480.0	307.0	307.0	307.0	22.902817049	1.045	1.13	7.039898394	1.045	1.045	7.024	5.513	0.012498	0.018179	0.013149	30.0
18	37124499	37124484	37124484	-480.0	307.0	307.0	307.0	22.902817025	1.045	1.13	7.039898394	1.045	1.045	7.024	5.513	0.012498	0.018179	0.013149	30.0
19	37124499	37124489	37124489	-480.0	307.0	307.0	307.0	22.902817087	1.045	1.13	7.039898394	1.045	1.045	7.024	5.513	0.012498	0.018179	0.013149	30.0
20	37124499	37124484	37124484	-480.0	307.0	307.0	307.0	22.902817049	1.045	1.13	7.039898394	1.045	1.045	7.024	5.513	0.012498	0.018179	0.013149	30.0
21	37124499	37124489	37124489	-480.0	307.0	307.0	307.0	22.902817025	1.045	1.13	7.039898394	1.045	1.045	7.024	5.513	0.012498	0.018179	0.013149	30.0
22	37124499	37124484	37124484	-480.0	307.0	307.0	307.0	22.902817087	1.045	1.13	7.039898394	1.045	1.045	7.024	5.513	0.012498	0.018179	0.013149	30.0
23	37124499	37124489	37124489	-480.0	307.0	307.0	307.0	22.902817049	1.045	1.13	7.039898394	1.045	1.045	7.024	5.513	0.012498	0.018179	0.013149	30.0
24	37124499	37124484	37124484	-480.0	307.0	307.0	307.0	22.902817025	1.045	1.13	7.039898394	1.045	1.045	7.024	5.513	0.012498	0.018179	0.013149	30.0
25	37124499	37124489	37124489	-480.0	307.0	307.0	307.0	22.902817087	1.045	1.13	7.039898394	1.045	1.045	7.024	5.513	0.012498	0.018179	0.013149	30.0
26	37124499	37124484	37124484	-480.0	307.0	307.0	307.0	22.902817049	1.045	1.13	7.039898394	1.045	1.045	7.024	5.513	0.012498	0.018179	0.013149	30.0
27	37124499	37124489	37124489	-480.0	307.0	307.0	307.0	22.902817025	1.045	1.13	7.039898394	1.045	1.045	7.024	5.513	0.012498	0.018179	0.013149	30.0
28	37124499	37124484	37124484	-480.0	307.0	307.0	307.0	22.902817087	1.045	1.13	7.039898394	1.045	1.045	7.024	5.513	0.012498	0.018179	0.013149	30.0
29	37124499	37124489	37124489	-480.0	307.0	307.0	307.0	22.902817049	1.045	1.13	7.039898394	1.045	1.045	7.024	5.513	0.012498	0.018179	0.013149	30.0
30	37124499	37124484	37124484	-480.0	307.0	307.0	307.0	22.902817025	1.045	1.13	7.039898394	1.045	1.045	7.024	5.513	0.012498	0.018179	0.013149	30.0
31	37124499	37124489	37124489	-480.0	307.0	307.0	307.0	22.902817087	1.045	1.13	7.039898394	1.045	1.045	7.024	5.513	0.012498	0.018179	0.013149	30.0

1. Photo series number: the series number of the image log file stored in this folder.
2. GPS TOW: when the photo was taken expressed in GPS TOW.
3. GPS Week: when the photo was taken expressed in GPS week.
4. Compensation value in the north direction: unit is in mm and the north direction is represented by a positive value.
5. Compensation value in the east direction: unit is in mm and the east direction is represented by a positive value.
6. Compensation value in the elevation direction: unit is in mm and the downward direction is represented by a positive value.
7. Longitude after compensation.
8. Latitude after compensation.
9. Ellipsoid height.
- 10 Positioning standard deviation in north direction.
11. Positioning standard deviation in east direction.
12. Positioning standard deviation in elevation direction.
13. Positioning status.

GNSS Observation File

The GNSS observation file with the extension .bin contains the satellite observation data of the four dual-band (L1+L2) GNSS systems (GPS, GLONASS, Galileo, BeiDou) received by the positioning module during the flight. The data is stored in the camera system in RTCM3.2 format at a frequency of 5 Hz. The data includes the original observation information and ephemeris information of the four GNSS systems.

Maintenance

Exporting Log

Exporting Gimbal Log

The gimbal log is stored in the microSD card of the P1. Users can copy it directly from the microSD card for processing and analysis.

Exporting Camera Log

Go to camera view in DJI Pilot, select ●●●, and then Export Zenmuse P1 Log to export the camera log to the SD card of the P1.

Firmware Update

Using DJI Pilot

1. Make sure that the P1 is securely mounted onto the aircraft, that there is a strong connection between the aircraft and remote controller and other DJI devices used with the aircraft, and that all devices are powered on.
2. Go to HMS in DJI Pilot, select Firmware Update, then Zenmuse P1, and follow the on-screen instructions to update the firmware. All available devices can be updated at the same time by selecting Update All.

Using SD Card

Make sure that the P1 is securely mounted onto the aircraft and the aircraft is powered off. Check that there is enough free space on the SD card and the Intelligent Flight Batteries are fully charged.

1. Visit the Zenmuse P1 product page on the DJI official website and go to downloads.
2. Download the latest firmware file.
3. Copy the downloaded firmware update file to the root directory of the SD card.
4. Insert the SD card into the SD card slot of the P1.
5. Power on the aircraft. The gimbal and camera perform an auto-check and will start to update automatically. The gimbal will beep to indicate the status of the firmware update.
6. Restart the device after the firmware update is complete.

Update Status Alarm

Alarm	Description
1 short beep	A firmware update has been detected. Preparing to update
4 short beeps	Updating firmware. Do not stop the update
1 long beep followed by 2 short beeps	The firmware update was successful
Continuous long beep	The firmware update failed. Try again. Contact DJI support for help if needed



- Make sure that there is only one firmware update file on the SD card.
- Do not power off the aircraft or detach the gimbal and camera while updating the firmware.
- It is recommended to delete the firmware update file on the SD card once the firmware is updated.

Specifications

General	
Product Name	ZENMUSE P1
Size	198×166×129 mm
Weight	Approx. 800 g
IP Rating	IP4X
Supported Aircraft	Matrice 300 RTK
Power	20 W
Operating Temperature Range	-20° to 50° C (-4° to 122° F)
Storage Temperature Range	-20° to 60° C (-4° to 140° F)
Absolute Accuracy	Horizontal: 3 cm, Vertical: 5 cm [†]
Camera	
Sensor	Sensor size (photo): 35.9×24 mm (full frame) Sensor size (video): 34×19 mm (max recording area) Effective pixels: 45 MP Pixel size: 4.4 μm
Supported Lenses	DJI DL 24mm F2.8 LS ASPH Lens (with lens hood and balancing ring/filter), FOV 84° DJI DL 35mm F2.8 LS ASPH Lens (with lens hood and balancing ring/filter), FOV 63.5° DJI DL 50mm F2.8 LS ASPH Lens (with lens hood and balancing ring/filter), FOV 46.8°
Supported SD Cards	SD: UHS-1 rating or above; Max capacity: 512 GB
Recommended SD Cards	Lexar Professional 633x 128GB SDXC UHS-I Card Lexar Professional 633x 256GB SDXC UHS-I Card Lexar Professional 633x 512GB SDXC UHS-I Card Lexar Professional 667X 256GB SDXC UHS-I/U3 Card Lexar Professional 667X 128GB SDXC UHS-I/U3 Card Lexar Professional 1066x 128GB SDXC UHS-I Card Lexar Professional 1667X 128GB SDXC UHS-II/U3 Card Lexar Professional 1667X 256GB SDXC UHS-II/U3 Card Lexar Professional 2000x 128GB SDXC UHS-II Card SanDisk 128GB Extreme PRO SDXC UHS-I Card SanDisk 512GB Extreme PRO SDXC UHS-I Card SanDisk 128GB SDXC SD Extreme PRO UHS-II Card Samsung PRO Plus SDXC Full Size SD Card 128GB Samsung PRO Plus SDXC Full Size SD Card 256GB Sony E series SDXC UHS-II Card 256GB Sony M Series SDXC UHS-II Card 128GB
Storage Files	Photo/Raw GNSS Observation Data/Image Log File
Photo size	3:2 (8192×5460)
Operation Modes	Photo, Video, Playback
Minimum Photo Interval	0.7 s
Shutter Speed	Mechanical Shutter Speed: 1/2000-1 s ² Electronic Shutter Speed: 1/8000-1 s
Aperture Range	f/2.8-f/16

ISO Range	Photo: 100-25600 Video: 100-25600
Video Format	MP4, MOV
Video Resolution	16:9 (1920×1080) 16:9 (3840×2160) ^③
Frame Rate	60 fps
Gimbal	
Stabilized System	3-axis (tilt, roll, pan)
Angular Vibration Range	±0.01°
Mount	Detachable DJI SKYPORT
Controllable Range	Tilt: -130° to +40° Roll: -55° to +55° Pan: ±320°

- ① Absolute accuracy measured with an aircraft with a GSD of 3 cm, flight speed of 15 m/s, 75% forward overlap ratio, and 55% side overlap ratio.
- ② Aperture value no larger than f/5.6. The camera will automatically switch to the electronic shutter when the shutter speed is larger than 1/10 s.
- ③ Only 35mm lens supported.



WE ARE HERE FOR YOU



Contact **DJI SUPPORT**
via Facebook Messenger

This content is subject to change.



Download the latest version from
<http://www.dji.com/zenmuse-p1>

If you have any questions about this document, please contact DJI by sending a message to **DocSupport@dji.com**.

Copyright © 2020 DJI All Rights Reserved.