

MAVIC 2 ENTERPRISE SERIES

User Manual v1.8

2021.04

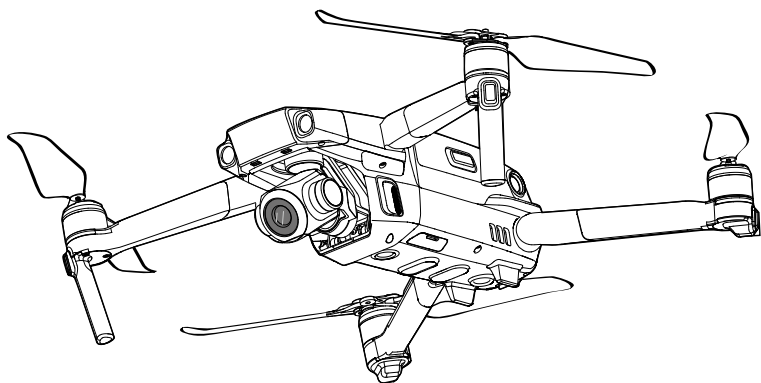

Searching for Keywords

Search for keywords such as “battery” and “install” to find a topic. If you are using Adobe Acrobat Reader to read this document, press Ctrl+F on Windows or Command+F on Mac to begin a search.

Navigating to a Topic

View a complete list of topics in the table of contents. Click on a topic to navigate to that section.

Printing this Document

This document supports high resolution printing.

Using This Manual

Legend

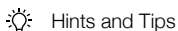

Read Before the First Flight

Read the following documents before using the MAVIC™ 2 Enterprise series:

1. In the Box
2. User Manual
3. Quick Start Guide
4. Disclaimer and Safety Guidelines
5. Intelligent Flight Battery Safety Guidelines

It is recommend to watch all tutorial videos on the official DJI™ website and read the Disclaimer and Safety Guidelines before first time use. Prepare for your first flight by reviewing the Quick Start Guide and refer to this User Manual for more details.

Video Tutorials

Go to the address below or scan the QR code on the right to watch the Mavic 2 Enterprise series tutorial videos, which demonstrate how to use the Mavic 2 Enterprise series safely:
<http://www.dji.com/mavic-2-enterprise/info#video>



Download the DJI Pilot App

Be sure to use the DJI Pilot app during flight. * Scan the QR code on the right to download the latest version. The Android version of DJI Pilot is compatible with Android v5.0 and later. The iOS version of DJI Pilot is compatible with iOS v10.0 and later.



* For increased safety, flight is restricted to a height of 98.4 ft (30 m) and range of 164 ft (50 m) when not connected or logged into the app during flight. This applies to DJI Pilot and all apps compatible with DJI aircraft.

Download DJI Assistant 2 for Mavic

Download DJI ASSISTANT™ 2 for Mavic at <http://www.dji.com/mavic-2-enterprise/info#downloads>.



The operating temperature of this product is -10° to 40° C. It does not meet the standard operating temperature for military grade application (-55° to 125° C), which is required to endure greater environmental variability. Operate the product appropriately and only for applications that it meets the operating temperature range requirements of that grade.

Contents

| | |
|---|----|
| Using This Manual | 2 |
| Legend | 2 |
| Read Before the First Flight | 2 |
| Video Tutorials | 2 |
| Download the DJI Pilot App | 2 |
| Download DJI Assistant 2 for Mavic | 2 |
| Product Profile | 6 |
| Introduction | 6 |
| Preparing the Aircraft | 7 |
| Preparing the Remote Controller | 8 |
| Aircraft Diagram | 10 |
| Activation | 13 |
| Aircraft | 15 |
| Flight Modes | 15 |
| Aircraft LEDs and Status Indicator | 16 |
| Return to Home | 17 |
| Vision Systems and Infrared Sensing Systems | 21 |
| Advanced Pilot Assistance Systems | 24 |
| Flight Recorder | 25 |
| Password Protection | 25 |
| Attaching and Detaching the Propellers | 25 |
| Intelligent Flight Battery | 26 |
| Gimbal and Camera | 30 |
| DJI AirSense | 32 |
| Modular Accessories | 33 |
| Remote Controller | 36 |
| Using the Remote Controller | 36 |
| Linking the Remote Controller | 42 |
| DJI Pilot App | 44 |
| Manual Flight | 44 |
| Mission Flight | 51 |
| Album | 53 |
| DJI FlightHub | 53 |

| | |
|---|----|
| Flight | 55 |
| Flight Environment Requirements | 55 |
| Flight Limits and GEO Zones | 55 |
| Pre-Flight Checklist | 56 |
| Starting/Stopping the Motors | 57 |
| Test Flight | 58 |
| Appendix | 60 |
| Specifications | 60 |
| Calibrating the Compass | 64 |
| Firmware Updates | 65 |
| Remote Controller LCD Screen Menu Information | 66 |
| After-Sales Information | 67 |

Product Profile

This section introduces Mavic 2 Enterprise series and lists the components of the aircraft and remote controller.

Product Profile

Introduction

The DJI Mavic 2 Enterprise series features omnidirectional Vision Systems and Infrared Sensing Systems. DJI signature technologies such as Obstacle Sensing and the Advanced Pilot Assistance System*, help you capture complex shots effortlessly. Additional features like the built-in AirSense makes you aware of your surrounding airspace, and password protection helps you maintain secure access to your aircraft and protect your data. The Mavic 2 Enterprise series also has attachable modular accessories like the M2E Spotlight, M2E Beacon and M2E speaker that are purpose-built for various industrial applications.

The Mavic 2 Enterprise features a fully stabilized 3-axis gimbal camera that shoots 4K video, 12-megapixel photos, supports 2x optical zoom, 24-48 mm lens, and supports filters.

The Mavic 2 Enterprise Dual features a fully stabilized 3-axis gimbal camera with a FLIR longwave infrared thermal camera and a visual camera, providing both infrared and visible light imaging simultaneously. The infrared thermal camera records 640×480 video, and the visual camera captures 4K videos and 12MP photos.

The Mavic 2 Enterprise series uses the latest technology to increase stability and footage quality, reducing the Mavic 2 Enterprise angle vibration range to within $\pm 0.005^\circ$ and Mavic 2 Enterprise Dual angle vibration range to within $\pm 0.01^\circ$.

Built into the remote controller is DJI's long-range transmission technology OCUSYNC™ 2.0, offering a maximum transmission range of 6.2 mi (10 km) and displaying video from the aircraft to DJI Pilot on your mobile device at up to 1080p. The remote controller works at both 2.4 GHz and 5.8 GHz, and it can select the best transmission channel automatically without any latency. The aircraft and camera can easily be controlled using the onboard buttons. An onboard LCD screen gives real-time aircraft data information, and the detachable control sticks make the remote controller easier to store. The maximum run time is 2 hours and 15 minutes. The Mavic 2 Enterprise series boasts a maximum flight speed of 44.7 mph (72 kph) and a maximum flight time of 31 minutes.



- The major difference between the Mavic 2 Enterprise and Mavic 2 Enterprise Dual is the camera. The general descriptions in this manual apply to both Mavic 2 Enterprise series.



- Maximum flight time was tested in an environment with no wind while flying at a consistent 15.5 mph (25 kph) and the maximum flight speed was tested at sea level altitude with no wind. These values are for reference only.
 - The remote controller reaches its maximum transmission distance (FCC) in a wide-open area with no electromagnetic interference at an altitude of about 400 ft (120 m). The maximum runtime was tested in a laboratory environment. This value is for reference only.
 - 5.8 GHz is not supported in some regions. Please observe the local laws and regulations.
-

* The Advanced Pilot Assistance System is not supported for Mavic 2 Enterprise Dual.

Preparing the Aircraft

All aircraft arms are folded before the aircraft is packaged at the factory. Follow the steps below to unfold the aircraft.

1. Remove the gimbal cover from the camera.
2. Unfold the front arms, and then unfold the rear arms.

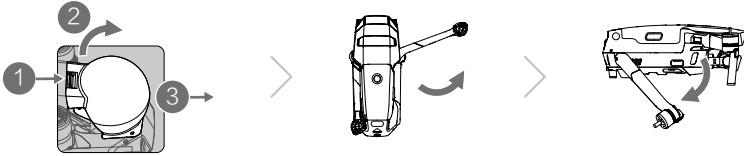

*Attach the gimbal cover when not in use.

- 1) Hold the gimbal in place and insert gimbal clamp between the aircraft and the gimbal.
- 2) Make sure the hooks on the Gimbal Protector are locked in the grooves of the aircraft, then lower the Gimbal Protector over the gimbal and secure with the buckle. The buckle will click when it is securely attached.

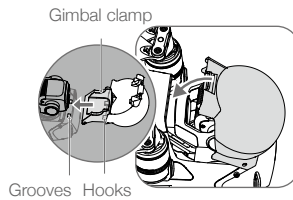

3. Attaching the propellers.

Attach the propellers marked white to the motors with white marks. Press the propeller down onto the motors and turn until it is secure. Attach the other propellers to the unmarked motors. Unfold the propeller blades.

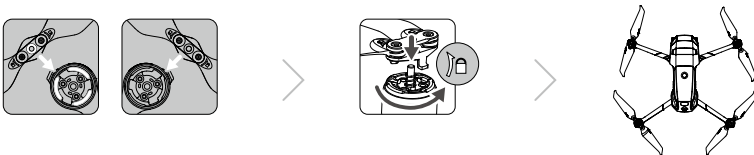

4. All Intelligent Flight Batteries are in Hibernation mode before shipment to ensure safety. Use the provided AC power adapter to charge and activate Intelligent Flight Batteries for the first time. To charge an Intelligent Flight Battery after flight, remove it from the aircraft and attach it to the AC power adapter.

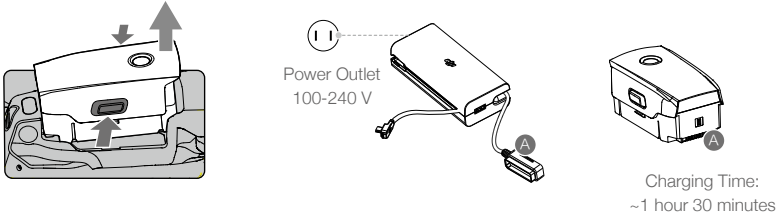

- Unfold the front arms and propellers before unfolding the rear arms.
- It is normal if there is friction on the arms and aircraft due to the firmly folding design of the Mavic 2 Enterprise series aircraft.
- Be sure the gimbal cover is removed and all arms and propellers are unfolded before powering on the aircraft. Otherwise, it may affect the aircraft self-diagnostics.

Preparing the Remote Controller

1. Unfold the mobile device clamps and the antennas.
2. Remove the control sticks from their storage slots on the remote controller and screw them into place.

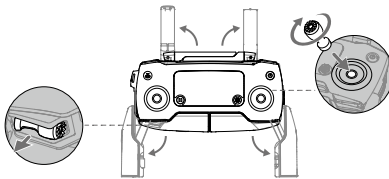

3. Choose an appropriate RC cable based on the type of mobile device. A cable with a Lightning connector is connected by default to the cable slider. Micro USB and USB-C cables are also included in the packaging. Connect the end of the RC cable to your mobile device. Secure your mobile device by pushing both clamps inward.

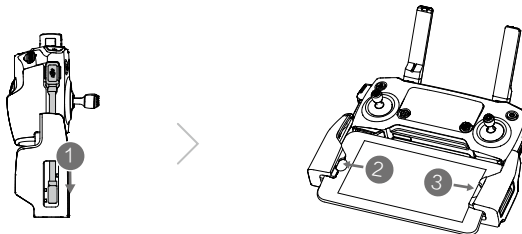

Refer to the figure below for how to replace the RC cable. The RC cable slider must be replaced if using a USB-C RC cable.



- You can also connect your mobile device to the remote controller using a USB cable if the mobile device is too big to place into the clamps. Plug one end of the cable into your mobile device and the other end into the USB port on the bottom of the remote controller.
 - Do not use the Micro USB and USB ports simultaneously for video linking. Remove the cable from one port before connecting a device to the other port for video linking.
-

Aircraft Diagram

Mavic 2 Enterprise (Model: L1ZE)

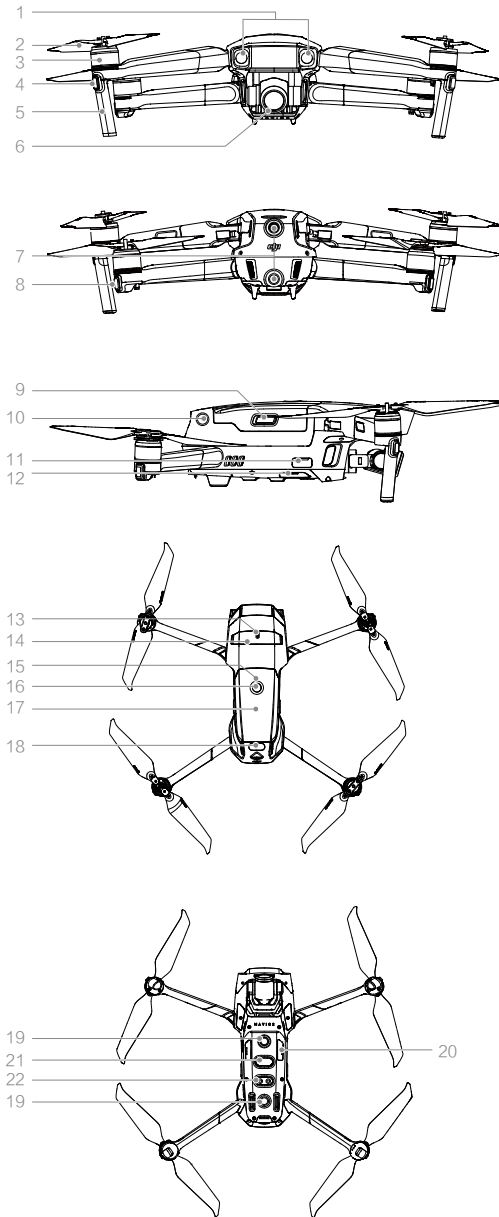

1. Forward Vision System
2. Propellers
3. Motors
4. Front LEDs
5. Antennas
6. Gimbal and Camera
7. Backward Vision System
8. Aircraft Status Indicator
9. Battery Buckles
10. Lateral Vision System
11. USB-C Port
12. Link Button/Linking Status Indicator
13. Extended Port (to connect accessories)
14. Extended Port Cover
15. Battery Level LEDs
16. Power Button
17. Intelligent Flight Battery
18. Upward Infrared Sensing System
19. Downward Vision System
20. microSD Card Slot
21. Downward Infrared Sensing System
22. Auxiliary Bottom Light (can be used as a beacon in low light conditions)

Mavic 2 Enterprise Dual (Model: L1DE)

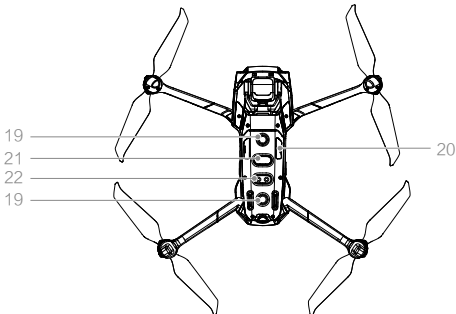
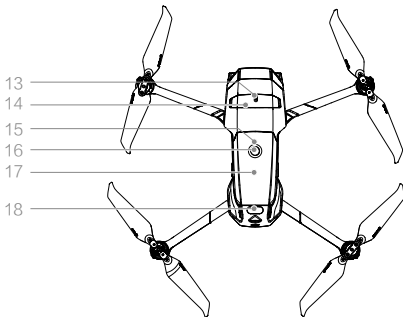
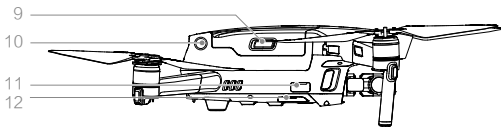
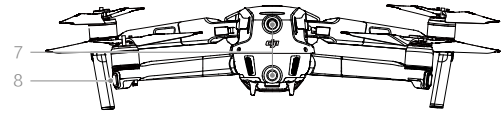
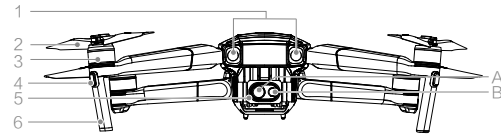

1. Forward Vision System
2. Propellers
3. Motors
4. Front LEDs
5. Gimbal and Camera
 - A. Visual Camera
 - B. Thermal Camera
6. Antennas
7. Backward Vision System
8. Aircraft Status Indicator
9. Battery Buckles
10. Lateral Vision System
11. USB-C Port
12. Link Button/Linking Status Indicator
13. Extended Port (to connect accessories)
14. Extended Port Cover
15. Battery Level LEDs
16. Power Button
17. Intelligent Flight Battery
18. Upward Infrared Sensing System
19. Downward Vision System
20. microSD Card Slot
21. Downward Infrared Sensing System
22. Auxiliary Bottom Light (can be used as a beacon in low light conditions)

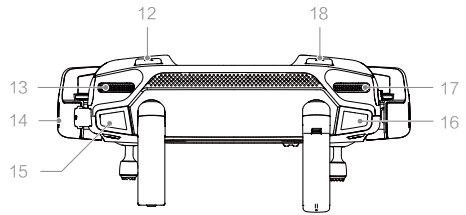
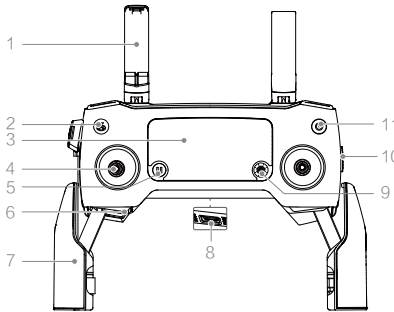

1. Antennas

Relay aircraft control and video wireless signals.

2. Return to Home (RTH) Button

Press and hold the button to initiate RTH. The aircraft returns to the last recorded Home Point. Press again to cancel RTH.

3. LCD Screen

Displays the aircraft and remote controller system status.

4. Removable Control Sticks

The removable control sticks are easy to store. The default flight control is set to Mode 2. Set the flight control mode in DJI Pilot.

5. Flight Pause Button

Press to make the aircraft brake and hover in place (only when GPS or Vision System are available).

6. Control Sticks Storage Slot

For storing the control sticks.

7. Mobile Device Clamps

Securely mount your mobile device onto the remote controller.

8. Reserve Video-Downlink Port (USB)

Connect to a mobile device for video downlink via a standard USB cable.

9. 5D Button

The default configuration is listed below. The configuration can be adjusted based on your preferences in DJI Pilot.

Left: Decrease EV value.

Right: Increase EV value.

Up: Recenter gimbal/gimbal downward.

Down: Recenter gimbal/gimbal downward.

10. Flight Mode Switch

Switch between S-mode, P-mode, and T-mode.

11. Power Button

Press once to check the current battery level. Press once, then again, and hold to turn on/off the remote controller.

12. C1 Button (Customizable)

The default configuration is center focus. Adjust the configuration in DJI Pilot based on your preferences.

13. Gimbal Dial

Controls the camera's tilt.

14. Video-Downlink/Power Port (micro USB)

Connect to a mobile device for video linking via the RC cable. Connect to the AC Power Adapter to charge the remote controller battery.

15. Record Button

Press to start recording video. Press again to stop recording.

16. Focus/Shutter Button

Press halfway to autofocus. Press once to take photos according to the mode selected in the DJI Pilot.

17. Zoom Adjustment Dial (Mavic 2 Enterprise)

Turn to adjust the zoom of the camera.

EV Adjustment Dial (Mavic 2 Enterprise Dual)

Turn to adjust the exposure value of the camera.

18. C2 Button (Customizable)

The default configuration is playback. Adjust the configuration in DJI Pilot based on your preferences.

Activation

The Mavic 2 Enterprise series requires activation before first time use. Follow the onscreen guide to activate the Mavic 2 Enterprise series using DJI Pilot.

Aircraft

This section introduces the flight controller, Intelligent Flight Battery, and the Forward, Backward and Downward Vision Systems.

Aircraft

The Mavic 2 Enterprise series contains a flight controller, vision systems, video downlink system, propulsion system, and an Intelligent Flight Battery. Refer to the aircraft diagram in the Product Profile section.

Flight Modes

The Mavic 2 Enterprise series has three flight modes, plus a fourth flight mode that the aircraft switches to in certain circumstances:

P-mode (Positioning): P-mode works best when the GPS signal is strong. The aircraft utilizes GPS and the Vision Systems to locate itself, stabilize, and navigate between obstacles.

When the Forward and Backward Vision Systems are enabled and lighting conditions are sufficient, the maximum flight altitude angle is 25°, the maximum forward flight speed is 31 mph (50 kph), and the maximum backward flight speed is 27 mph (43 kph).

Note: P-mode requires larger stick movements to achieve high speeds.

The aircraft automatically changes to Attitude (ATTI) mode when the Vision Systems are unavailable or disabled and when the GPS signal is weak or the compass experiences interference. When the Vision Systems are unavailable, the aircraft cannot position itself or brake automatically, which increases the risk of potential flight hazards. In ATTI mode, the aircraft may be more easily affected by its surroundings. Environmental factors such as wind can result in horizontal shifting, which may present hazards, especially when flying in confined spaces.

S-mode (Sport): In S-mode, the Obstacle Sensing function is disabled and the aircraft uses GPS and the Vision Systems for positioning. The maximum flight speed is 44.7 mph (72kph). The aircraft cannot sense or avoid obstacles.

Note: In S-mode, aircraft responses are optimized for agility and speed making it more responsive to stick movements.

T-mode (Tripod): T-mode is based on P-mode and the flight speed is limited, which makes the aircraft more stable during shooting. The maximum flight speed, maximum ascend speed and maximum descend speed are 1 m/s.



- The Obstacle Sensing function and the Upward Infrared Sensing System are disabled in S-mode, which means the aircraft cannot sense obstacles on its route automatically.
 - The aircraft's maximum speed and braking distance significantly increase in S-mode. A minimum braking distance of 98.4 ft (30 m) is required in windless conditions.
 - Descent speed significantly increases in S-mode.
 - The aircraft's responsiveness significantly increases in S-mode, which means a small stick movement on the remote controller translates into the aircraft moving a large distance. Be vigilant and maintain adequate maneuvering space during flight.
 - Use the Flight Mode switch on the remote controller to switch between Flight Modes. Enable Multiple Flight Modes in DJI Pilot to switch between Flight Modes.
-

Aircraft LEDs and Status Indicator

The Mavic 2 Enterprise series has Front LEDs and Aircraft Status Indicators as shown in the figure below.

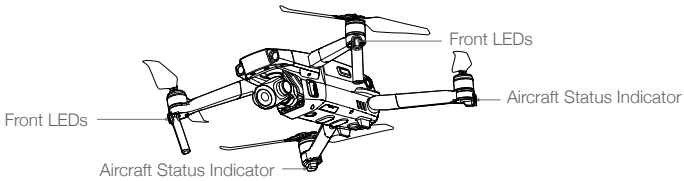

The Front LEDs show the orientation of the aircraft and glow solid red when the aircraft is turned on to indicate the front of the aircraft (they can be turned off in the DJI Pilot).

The Aircraft Status Indicators communicate the status of the aircraft's flight control system. Refer to the table below for more information about the Aircraft Status Indicators. The Aircraft Status Indicators also flash when the Home Point is being recorded, as described in the Return to Home section.

Aircraft Status Indicator States



| | Color | Blinking/Solid | Description of Aircraft State |
|-----------------------|------------------------------------|---------------------------|---|
| Normal States | | | |
| | Alternating red, green, and yellow | Blinking | Turning on and performing self-diagnostic tests |
| | Yellow | Blinks four times | Warming up |
| | Green | Blinking slowly | P-mode with GPS |
| | Green | Periodically blinks twice | P-mode with Forward and Downward Vision Systems |
| | Yellow | Blinking slowly | No GPS, Forward Vision System or Downward Vision System |
| | Green | Blinking quickly | Braking |
| Warning States | | | |
| | Yellow | Blinking quickly | Remote controller signal lost |
| | Red | Blinking slowly | Low battery |
| | Red | Blinking quickly | Critically low battery |
| | Red | Blinking | IMU error |
| | Red | Solid | Critical error |
| | Alternating red and yellow | Blinking quickly | Compass calibration required |



- For missions that require concealed flight, enter common settings in DJI Pilot and select LED Settings and turn the Frame Arm LEDs off.

Return to Home

The Return to Home (RTH) function brings the aircraft back to the last recorded Home Point. There are three types of RTH: Smart RTH, Low Battery RTH, and Failsafe RTH. This section describes these three scenarios in detail.

| ☰ | GPS | Description |
|------------|---|--|
| Home Point |  | If a strong GPS signal was acquired before takeoff, the Home Point is the location from which the aircraft launched. The GPS signal strength is indicated by the GPS icon (). The Aircraft Status Indicator will blink green quickly when the Home Point is recorded. |

Smart RTH

If the GPS signal is sufficiently strong, Smart RTH can be used to bring the aircraft back to the Home Point. Smart RTH is initiated by pressing and holding the RTH button on the remote controller.

Exit Smart RTH by pressing the RTH button on the remote controller.

Low Battery RTH

Low Battery RTH is triggered when the Intelligent Flight Battery is depleted to the point that the safe return of the aircraft may be affected. Return home or land the aircraft immediately when prompted. DJI Pilot displays a warning when the battery level is low. The aircraft will automatically return to the Home Point if no action is taken after a ten-second countdown. The user can cancel RTH by pressing the RTH button or Flight Pause button on the remote controller.

If RTH is cancelled following a low battery level warning, the Intelligent Flight Battery may not have enough charge for the aircraft to land safely, which may lead to the aircraft crashing or being lost. The thresholds for the battery level warnings are automatically determined based on the aircraft's current altitude and distance from the Home Point.

The aircraft will land automatically if the current battery level can only support the aircraft long enough to descend from its current altitude. The user cannot cancel the auto landing but can use the remote controller to alter the aircraft's orientation during the landing process.

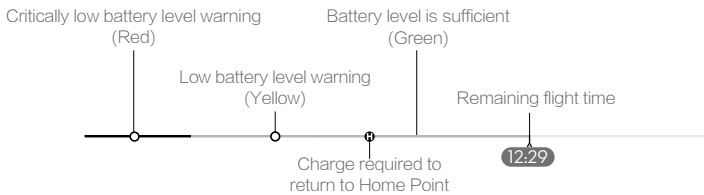

DJI Pilot Battery Level Indicator Bar



- The colored zones and markers on the DJI Pilot battery level indicator bar reflect the estimated remaining flight time. They automatically adjust according to the aircraft's current location and status.
- If the current battery level can only support the aircraft long enough to descend from its current altitude, a critically low battery level warning triggers and the aircraft descends and lands automatically. This cannot be canceled. If there is a danger of a collision, push the throttle up and try to navigate away.
- If the battery level is sufficient, the battery level indicator bar in DJI Pilot displays the estimated remaining flight time based on the current battery level.

| Warning | Instructions | Aircraft Status Indicator | DJI Pilot App | Actions |
|------------------------------|---|---------------------------|---|--|
| Low Battery Level | Remaining battery level supports RTH. | Blinks red slowly | Choose RTH or resume normal flight. | Select an option. If no action is taken, the aircraft will enter RTH. |
| | Remaining battery level supports Emergency RTH (when in RTH, with a normal RC signal, and at an altitude higher than 50 m). | | Choose Emergency RTH or resume RTH. | Select an option. Emergency RTH (aircraft descends to 50 m and returns to the Home Point) or resume RTH (aircraft flies to Home Point without descending). If no action is taken, the aircraft will enter Emergency RTH. |
| | Remaining battery level supports Emergency Landing (when in RTH with a normal RC signal). | | Aircraft lands. Action cannot be canceled. | Aircraft lands immediately. |
| Critically Low Battery Level | Aircraft lands after 10 seconds (when flying normally with a critical low battery level). | Blinks red quickly | Aircraft lands after 10 seconds. Action cannot be canceled. | Aircraft lands after 10 seconds. |
| | Aircraft lands automatically (when flying normally with an extremely critical low battery level). | | Aircraft lands immediately. Action cannot be canceled. | Aircraft lands immediately. |

Failsafe RTH

The Forward Vision System allows the aircraft to create a real-time map of its flight route as it flies. If the Home Point was successfully recorded and the compass is functioning normally, Failsafe RTH automatically activates after the remote control signal is lost for more than two seconds.

When Failsafe RTH is activated, the aircraft starts to retrace its original flight route home. If the remote control signal is re-established within 60 seconds of Failsafe RTH being activated, the aircraft hovers at its present location for 10 seconds and waits for pilot commands. The user may press the RTH button on the remote controller to cancel Failsafe RTH and retake control. If no pilot command is given, the aircraft flies to the Home Point in a straight line. If the remote control signal is still lost 60 seconds after activating Failsafe RTH, the aircraft stops retracing its original flight route and flies to Home Point in a straight line.

RTH Procedure

Smart RTH, Low Battery RTH, and Failsafe RTH all follow the RTH procedure:

- The aircraft adjusts its orientation.
- If the aircraft is further than 20 m from the Home Point when the RTH procedure begins, it ascends to the pre-set RTH altitude and then flies to the Home Point at a speed of 12 m/s. If the current altitude is higher than the RTH altitude, the aircraft flies to the Home Point at the current altitude. Forward and Backward vision systems are enabled.
 - If the aircraft is between 5 m and 20 m from the Home Point when the RTH procedure begins:
 - If the RTH at Current Altitude option is enabled the aircraft flies to the Home Point at the current altitude, unless the current altitude is less than 2 m, in which case the aircraft ascends to 2 m and then flies to the Home Point at a speed of 3 m/s.
 - If the RTH at Current Altitude option is disabled, the aircraft lands immediately.
 - If the aircraft is less than 5 m from the Home Point when the RTH procedure begins, it lands immediately.
- After reaching the Home Point, the aircraft lands and the motors stop.

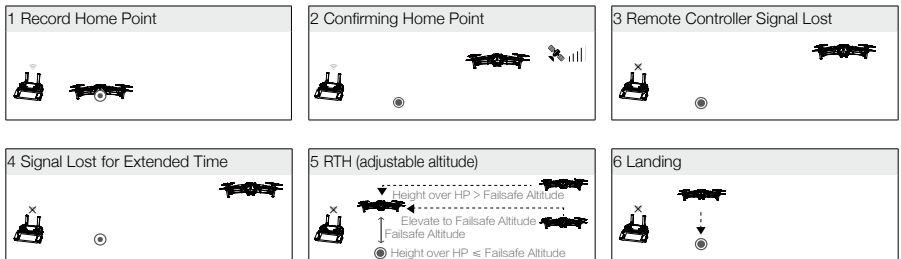

Obstacle Avoidance during RTH

Provided that lighting conditions are sufficient for the Forward and Backward Vision Systems to operate, the Mavic 2 Enterprise series senses and actively attempts to avoid obstacles during RTH. The obstacle avoidance procedure is as follows:

- The aircraft decelerates when an obstacle is sensed.
- The aircraft stops and hovers and then ascends until no obstacle is sensed.
- The RTH procedure resumes. The aircraft flies to the Home Point at the new altitude.

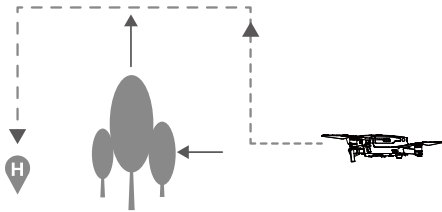

-
- ⚠ The aircraft cannot return to the Home Point if the GPS signal is weak or unavailable.
 - In Smart RTH and Low Battery RTH, the aircraft automatically ascends to an altitude of 65 ft (20 m). Once the altitude is 65 ft (20 m) or higher, move the throttle stick and the aircraft stops ascending and flies to the Home Point at its current altitude.
 - The aircraft cannot avoid obstacles during Failsafe RTH if the Forward and Backward Vision Systems are unavailable. It is important to set a suitable RTH Altitude before each flight. Launch DJI Pilot, tap  and then set the RTH Altitude.
 - During RTH, the aircraft's speed and altitude can be controlled using the remote controller or DJI Pilot, but the flight controller controls its orientation and direction of flight.
 - During RTH, obstacles on either side of the aircraft cannot be detected or avoided.
-

Landing Protection

Landing Protection activates during Smart RTH and the aircraft performs as follows:

1. When Landing Protection determines that the ground is suitable for landing, the aircraft lands gently.
2. If Landing Protection determines that the ground is not suitable for landing, the aircraft hovers and waits for the pilot to confirm it is suitable to land.
3. If Landing Protection is not operational, DJI Pilot displays a landing prompt when the aircraft descends below 0.5 m. Pull down on the throttle for one second or use the auto landing slider in the app to land.

Landing Protection activates during Low Battery RTH and Failsafe RTH. The aircraft performs as follows:

During Low Battery RTH and Failsafe RTH, the aircraft hovers at 2 m above the ground and waits for the pilot to confirm it is suitable to land. Pull down on the throttle for one second or use the auto landing slider in the app to land. Landing Protection activates and the aircraft performs the steps listed above.

-
- ⚠ Vision Systems are disabled during landing. Be sure to land the aircraft with caution.
-

Precision Landing

The Mavic 2 Enterprise series automatically scans and attempts to match the terrain features underneath during Return to Home. When the current terrain matches Home Point terrain, the Mavic 2 Enterprise series will start landing. The DJI Pilot app will show a terrain feature mismatch prompt if matching fails.



- Precision Landing performance is subject to the following conditions:
 - a. The Home Point must be recorded upon takeoff and must not be changed during flight, otherwise the aircraft will have no record of the Home Point's terrain features.
 - b. During takeoff the aircraft must ascend vertically 7 m before moving horizontally.
 - c. The Home Point terrain features must remain largely unchanged.
 - d. The Home Point terrain features must be sufficiently distinctive.
 - e. The lighting conditions must not be too light or too dark.
- The following actions are available during Precision Landing:
 - a. Throttle down to accelerate landing.
 - b. Move the control sticks in any other direction to stop Precision Landing. The Mavic 2 Enterprise series will descend vertically after the control sticks are released.

Vision Systems and Infrared Sensing Systems

The Mavic 2 Enterprise series is equipped with Forward, Backward, Downward, and Lateral Vision Systems, and Upward and Downward Infrared Sensing Systems, providing omnidirectional obstacle sensing (if lighting conditions are adequate).

The main components of the Forward, Backward, and Downward Vision Systems are six cameras located on the nose, rear side, and the underside of the aircraft. Lateral Vision Systems are two cameras located on either side of the aircraft.

The main components of the Upward and Downward Infrared Sensing Systems are two 3D infrared modules located on the upper and underside of the aircraft.

The Downward Vision System and Infrared Sensing System helps the aircraft maintain its current position and hover in place more precisely and to fly indoors or in other environments where a GPS signal is unavailable. In addition, the Auxiliary Bottom Light located on the underside of the aircraft improves visibility for the Downward Vision System in weak light conditions.

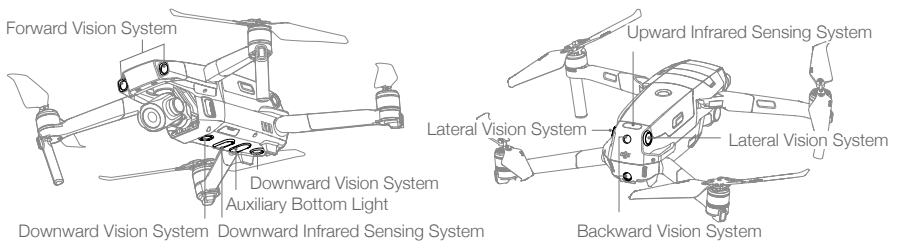

Detection Range

The detection range of the Vision Systems is depicted as followed. Please note that the aircraft cannot sense or avoid the obstacles that are not within detection range.

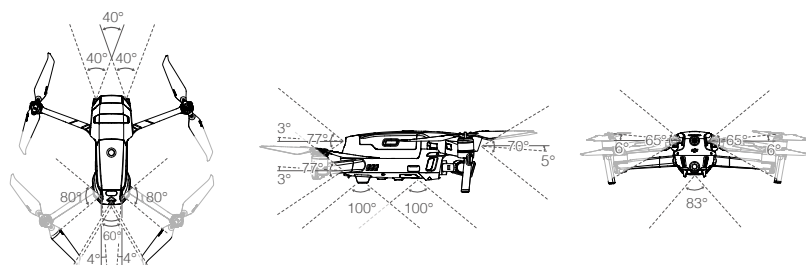

Calibrating Vision System Cameras

The Vision System cameras installed on the aircraft are factory calibrated. If the aircraft experiences a collision, however, it may require calibration via DJI Assistant 2 for Mavic or DJI Pilot.

The most accurate way to calibrate the Vision System cameras is by using DJI Assistant 2 for Mavic. Follow the steps below to calibrate the Forward Vision System cameras, then repeat the steps to calibrate other Vision System cameras.

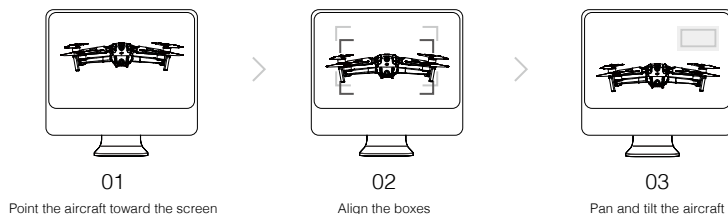

Using the Vision Systems

The Downward Vision System and Infrared Sensing System activate automatically when the aircraft is turned on. No further action is required. When using the Downward Vision System, the aircraft can hover precisely even without GPS.

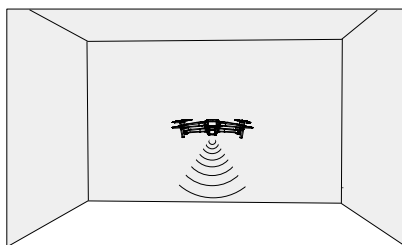

The Downward Vision System is typically used in indoor environments where GPS is unavailable. The Downward Vision System works best when the aircraft is at altitudes of 1.6 to 33 ft (0.5 to 11 m). Please note that the Vision Positioning function may be affected if the aircraft's altitude is above 33 ft (11 m).

Follow the steps below to use the Downward Vision System:

1. Ensure the aircraft is in P-mode and place the aircraft on a flat surface. Please note that the Downward Vision System cannot work properly on surfaces without clear pattern variations.
2. Turn on the aircraft. The aircraft hovers in place after takeoff. The Aircraft Status Indicators flash green twice, which indicates the Downward Vision System is working.



Using the Forward and Backward Vision Systems, the aircraft can actively brake when detecting obstacles in front. The Forward and Backward Vision Systems work best with adequate lighting and clearly marked or textured obstacles. To allow for sufficient time to brake, the aircraft should not fly more than 31 mph (50 kph) when flying forward or more than 27 mph (42 kph) when flying backward.

The Lateral Vision Systems requires better lighting and more textured or clearly marked obstacles, and cannot sense dynamic objects, such as moving people, vehicles, tree branches, or blinking lights. The Lateral Vision Systems are only available in Tripod Mode. The angular speed is limited to 24° /s and the lateral flight speed is limited to 18 mph (29 km/h).



- Lateral Vision Systems have limited ability to sense and avoid obstacles, and the performance may be affected by the surrounding environment. Be sure to maintain line of sight with the aircraft and pay attention to prompts in DJI Pilot. DJI takes no responsibility for any aircraft that is damaged or lost while using Lateral Vision Systems.
- The Vision System cannot work properly over surfaces that DO NOT have clear pattern variations. The Vision System is only effective when the aircraft is at an altitude of 0.5 to 50 meters. Please note that the Vision Positioning function may be affected if the aircraft's altitude is above 33 ft (11 m).
- The Auxiliary Bottom Light is automatically enabled when the environment light is too weak and the flight altitude is lower than 5 m. Please note that the Vision System cameras performance may be affected when the auxiliary bottom light is enabled. Fly with caution if the GPS signal is weak.
- The Vision System may NOT function properly when the aircraft is flying over water or snow-covered areas.
- Note that the Vision System may NOT function properly when the aircraft is flying too fast. Fly with caution when flying at over 10 m/s (32.8 ft/s) at 2 m (6.6 ft) or over 5 m/s (16.4 ft) at 1 m (3.3 ft).
- Operate the aircraft cautiously when in any of the following situations:
 - a. Flying over monochrome surfaces (e.g., pure black, pure white, pure green).
 - b. Flying over highly reflective surfaces.
 - c. Flying over water or transparent surfaces.
 - d. Flying over moving surfaces or objects.
 - e. Flying in an area where the lighting changes frequently or drastically.
 - f. Flying over extremely dark (< 10 lux) or bright (> 40,000 lux) surfaces.
 - g. Flying over surfaces that strongly reflect or absorb infrared waves (e.g., mirrors).
 - h. Flying over surfaces without clear patterns or texture.
 - i. Flying over surfaces with repeating identical patterns or textures (e.g., tiles with the same design).
 - j. Flying over obstacles with small surface areas (e.g., tree branches).



- Keep the sensors clean at all times. DO NOT tamper with the sensors. Do not obstruct the Infrared Sensing System.
 - The Vision System may not be able to recognize patterns on the ground in low light conditions (less than 100 lux).
 - If the aircraft speed exceeds 31 mph (50 kph), the Vision System does not have enough time to brake and stop the aircraft at a safe distance from an obstacle.
 - If the aircraft experiences a collision, camera calibration is required. Calibrate the front cameras if DJI Pilot prompts you to do so.
 - Do not fly on days that are rainy, smoggy, or if there is no clear sight.
 - Check the following every time before takeoff:
 - a. Ensure there are no stickers or any other obstructions over the glass of the Infrared Sensing and Vision System.
 - b. If there is any dirt, dust, or water on the glass of the Infrared Sensing and Vision System, clean it with a soft cloth. Do not use any cleanser that contains alcohol.
 - c. Contact DJI Support if there is any damage to the glass of the Infrared Sensing and Vision System.
 - The Upward Infrared Sensing System only detects straight line distances directly above the sensor and not the entire aircraft. Additionally, large obstacles such as roofs can be detected, but tiny obstacles such as leaves or electrical wires cannot. Fly with caution and do not rely solely on the Upward Infrared Sensing System to detect obstacles above the aircraft.
 - Do not obstruct the Downward Vision System and Downward Infrared Sensing System before takeoff. Otherwise, the aircraft cannot take off again after landing and will have to be restarted.
-

Advanced Pilot Assistance Systems (Only Mavic 2 Enterprise is supported)

The Advanced Pilot Assistance Systems (APAS) feature is available in P-mode. When APAS is enabled, the aircraft continues to respond to user commands and plans its path according to both control stick inputs and the flight environment. APAS makes it easier to avoid obstacles, obtain smoother footage, and gives a better flying experience.

When APAS is enabled, pressing the Flight Pause button on the remote controller brings the aircraft to a stop. The aircraft hovers for three seconds and awaits pilot commands.

To enable APAS, tap  in DJI Pilot.



- The APAS feature is only available when flying forward and backward. If the aircraft flies left or right, APAS is disabled.
 - The aircraft hovers in place once there is an obstacle that cannot be avoided. The aircraft cannot detect and avoid obstacles that are beneath it.
 - Make sure you use the Advanced Pilot Assistance System (APAS) when the Vision Systems are available. Be sure there are no people, animals, objects with small surface areas (e.g., tree branches), or transparent objects (e.g., glass or water) along the desired flight path.
 - APAS may not function properly when the aircraft is flying over water or snow-covered area.
 - Be extra cautious when flying in extremely dark (< 300 lux) or bright (> 10,000 lux) environments.
 - APAS may not function properly when the aircraft is flying near its Flight Limits or in GEO Zones.
 - Pay attention to the Aircraft Status Bar in DJI Pilot and ensure the aircraft is working in APAS mode normally.
-

Flight Recorder

Flight data including flight telemetry, aircraft status information, and other parameters are automatically saved to the aircraft's internal data recorder. The data can be accessed using DJI Assistant 2 for Mavic.

Password Protection

The Mavic 2 Enterprise series supports password protection. This feature helps ensure secure access to your aircraft and its onboard data storage, thus preventing leakage of sensitive information.

To set, change or delete the password, launch the DJI Pilot app, select Settings > Security Password.



- The password is stored in the aircraft only and will not be uploaded to the DJI server. Therefore, you need to format the aircraft to delete the security password if you forget it. The data stored in the aircraft will be deleted once the aircraft is formatted.
- **To guarantee the maintenance, DJI will format the aircraft's onboard data. Please remove your security password and back up your data before sending your aircraft back for repair. DJI takes no responsibility for the data loss.**

Attaching and Detaching the Propellers

The Mavic 2 Enterprise series use low-noise propellers. There are two varieties of the propellers, which are designed to spin in different directions. White marks are used to indicate which propellers should be attached to which motors.

Marked



Unmarked



Attach on motors with white marks

Attach on motors without white marks



Turn the propellers in the indicated direction to mount and tighten.

Attaching the Propellers

Attach the propellers with the white marks to the motors with white marks and the unmarked propellers to the motors without marks. Press each propeller down onto the motor and turn until it is secure.

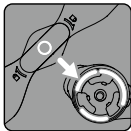

Marked

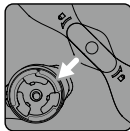

Unmarked

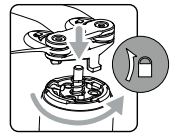
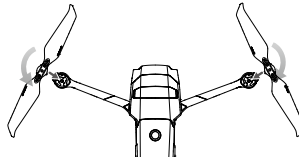

Detaching the Propellers

Press the propellers down onto the motors and rotate them in the unlock direction.



- Propeller blades are sharp. Handle with care.
 - Only use original DJI propellers. Do not mix propeller types.
 - Ensure that all propellers are in good condition before each flight. Do not use aged, chipped, or broken propellers.
 - Ensure that the propellers and motors are installed securely before each flight.
 - To avoid injury, stand clear of and do not touch propellers or motors when they are spinning.
 - To avoid damaging the propellers, place the aircraft in the direction shown in the carrying case during transportation or storage. Do not squeeze or bend the propellers. If propellers are damaged, the flight performance is affected.
 - Ensure the motors are mounted securely and rotating smoothly. Land the aircraft immediately if a motor is stuck and unable to rotate freely.
 - Keep the motors free of dust.
 - DO NOT attempt to modify the structure of the motors.
 - DO NOT touch or let your hands or body come in contact with the motors after flight as they may be hot.
 - DO NOT block any of the ventilation holes on the motors or the body of the aircraft.
 - Ensure the ESCs sound normal when powered on.
-

Intelligent Flight Battery

The Mavic 2 Intelligent Flight Battery is a 15.4 V, 3850 mAh battery with smart charging/discharging functionality. Only use a DJI approved AC power adapter to charge the battery.

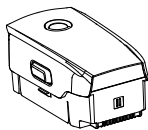

Intelligent Flight Battery

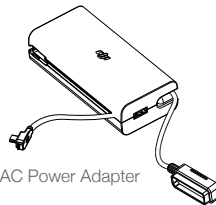

AC Power Adapter

Battery Features

1. **Battery Level Display:** The LED indicators display the current battery level.
2. **Auto-Discharging Function:** To prevent swelling, the battery automatically discharges to less than 60% of the maximum battery level when it is idle for more than 10 days. It takes approximately three to four days to discharge the battery to 65%. It is normal to feel moderate heat being emitted from the battery during the discharging process.
3. **Balanced Charging:** During charging, the voltages of the battery cells are automatically balanced.
4. **Overcharge Protection:** The battery stops charging automatically once fully charged.
5. **Temperature Detection:** The battery only charges when the temperature is between 41° and 104° F (5° and 40° C).

6. Overcurrent Protection: The battery stops charging if an excess current is detected.
7. Over-discharge Protection: Discharging stops automatically to prevent excess discharge.
8. Short Circuit Protection: The power supply is automatically cut if a short circuit is detected.
9. Battery Cell Damage Protection: DJI Pilot displays a warning message when a damaged battery cell is detected.
10. Hibernation Mode: The battery switches off after 20 minutes of inactivity to save power. If the battery level is less than 10%, the battery enters Hibernation mode to prevent over-discharge. In Hibernation mode, the battery level indicators do not illuminate. Charge the battery to wake it from hibernation.
11. Communication: Information about the battery's voltage, capacity, and current is transmitted to the aircraft.
12. Heating: Batteries of the Mavic 2 Enterprise series are self-heating, which makes them capable of working under harsh and cold weather conditions for as low -4° F (-20° C).

 Refer to the Mavic 2 Intelligent Flight Battery Safety Guidelines before use. Users take full responsibility for all operations and usage.

Using the Battery

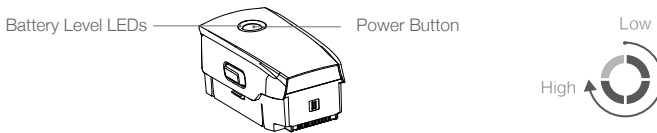

Checking Battery Level

The battery level LEDs display how much charge remains. If the battery is turned off, press the Power button, and the battery level LEDs light up to display the current battery level

Powering On/Off

Press the Power button once, then press again, and hold for two seconds to turn the battery on or off.

Heating the Battery

Manual Heating: Make sure the battery is powered off. Press and hold the Power Button for five seconds to initiate battery warm up manually.

The battery will warm up if the temperature is below 43 °F (6 °C) and the battery level is above 45%. As it warms up, the brightness of the LED indicators will change accordingly, signaling 'no LED light', low, medium, or high.

The battery will stop warming when it reaches 46 °F (8 °C), and the LED indicators will blink clockwise, indicating that the battery temperature is between 46 to 50 °F(8 to 10°C). This will last for approximately 20 minutes and then the battery will power off automatically.

Auto Heating: Insert the battery into the aircraft and power it on. When the temperature of the battery is below 43°F (6°C) and the battery level is above 45%, it will warm up automatically and the temperature will remain between 46 to 50 °F(8 to 10 °C).

Low Temperature Notice

1. Battery capacity is significantly reduced when flying in low-temperature environments of -4° to 41° F (-20° to 5° C). It is recommended to heat the battery before use, and ensure to fully charge the battery before takeoff.
2. Batteries cannot be used in extremely low-temperature environments of < -4° F (-20° C).
3. To ensure optimal performance of the battery, warm up the battery so the temperature is above 46 ° F (8° C) before use.
4. The reduced battery capacity in low-temperature environments reduces the aircraft's wind speed resistance. Please fly with caution.
5. Fly with extra caution at a high sea level.
6. The heating function cannot be initiated when the battery temperature is higher than 43 ° F (6 ° C) or the battery level is lower than 45%.
7. When the temperature is below -4°F (-20°C), the battery will trigger low temperature protection and will not power on. When the battery temperature reaches 5°F (-15°C) or above, the low temperature protection is automatically released.

Charging the Battery

Fully charge the Intelligent Flight Battery before using for the first time:

1. Connect the AC power adapter to a power source (100-240 V, 50/60 Hz).
2. Attach the Intelligent Flight Battery to the AC power adapter using the battery charging cable with the battery powered off.
3. The battery level LEDs display the current battery level during charging.
4. The Intelligent Flight Battery is fully charged when the battery level LEDs are all turned off. Detach the AC power adapter when the battery is fully charged.

Charging Time: 1 hour and 30 minutes.

-
- ⚠ • DO NOT charge an Intelligent Flight Battery immediately after flight as the temperature may be too high. Wait until it cools down to room temperature before charging again.
 - The AC power adapter stops charging the battery if the battery cell temperature is not within the operating range of 41° to 104° F (5° to 40° C). The ideal charging temperature is 71.6° to 82.4° F (22° to 28° C).
 - The Battery Charging Hub (not included) can charge up to four batteries. Please visit the official DJI Online Store to learn more.
-

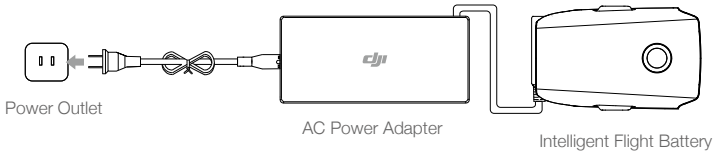

Battery Level LEDs During Charging

| | LED 1 | LED 2 | LED 3 | LED 4 |
|------------------------------------|--------|---------|---------|---------------|
| Battery Level LEDs During Charging | | | | |
| Battery Level | 0%~25% | 25%~50% | 50%~75% | Fully Charged |

Battery Protection

| Battery Protection Mechanisms | | | | | |
|-------------------------------|-------|-------|-------|-------------------------------------|----------------------------------|
| LED 1 | LED 2 | LED 3 | LED 4 | Blinking Pattern | Battery Protection Item |
| | | | | LED 2 blinks twice per second | Overcurrent detected |
| | | | | LED 2 blinks three times per second | Short circuit detected |
| | | | | LED 3 blinks twice per second | Overcharge detected |
| | | | | LED 3 blinks three times per second | Over-voltage charger detected |
| | | | | LED 4 blinks twice per second | Charging temperature is too low |
| | | | | LED 4 blinks three times per second | Charging temperature is too high |

Inserting the Intelligent Flight Battery

Insert the Intelligent Flight Battery into the aircraft's battery compartment. Make sure it is mounted securely and that the battery latches have clicked into place.

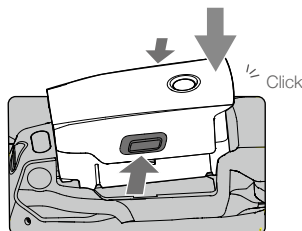

Removing the Intelligent Flight Battery

Slide the battery latches on the sides of the Intelligent Flight Battery to open the battery compartment.

- ⚠ • Never insert or remove the battery while it is turned on.
 - Ensure the battery is mounted securely.
-

Gimbal and Camera

Gimbal

The Mavic 2 Enterprise series 3-axis gimbal provides stabilization for the camera, allowing you to capture clear and stable images and video. The gimbal has a tilt range of -90° to $+30^\circ$. Gimbal settings such as Gimbal Mode and Gimbal Auto Calibration can be selected by tapping .

Use the gimbal dial on the remote controller to control the camera's tilt. Alternatively, enter Camera View in DJI Pilot. Press the screen until a blue circle appears and drag the circle up and down to control camera tilt. Dragging the circle left and right controls the aircraft's orientation.

Gimbal Operation Modes

Two gimbal operation modes are available. Switch between the different operation modes on the camera settings page of DJI Pilot.

Follow Mode: The angle between the gimbal's orientation and aircraft's nose remains constant at all times.

FPV Mode: The gimbal synchronizes with the movement of the aircraft to provide a first-person perspective flying experience.

- ⚠ • When the aircraft is powered on, do not tap or knock the gimbal. To protect the gimbal during takeoff, always take off from open and flat ground.
 - Precision elements in the gimbal may be damaged in a collision or impact, which may cause the gimbal to function abnormally.
 - Avoid getting dust or sand on the gimbal, especially in the gimbal motors.
 - A gimbal motor error may occur in the following situations:
 - a. The aircraft is on uneven ground or the gimbal's motion is obstructed.
 - b. The gimbal experiences excessive external force, such as during a collision.
 - DO NOT apply external force to the gimbal after the gimbal is powered on. DO NOT add any extra payload to the gimbal as this may cause the gimbal to function abnormally or even lead to permanent motor damage.
 - Make sure to remove the gimbal cover before powering on the aircraft. Also, make sure to mount the gimbal cover when the aircraft is not in use.
 - Flying in heavy fog or clouds may make the gimbal wet, leading to temporary failure. The gimbal recovers full functionality once it dries.
-

Camera

The Mavic 2 Enterprise uses a 1/2.3" CMOS sensor camera, supports 2x optical zoom, and the lens is 24-48 mm (35 mm format equivalent). The camera supports auto focus, which can focus at 0.5 m to infinity. The camera also supports replacing filters. The Mavic 2 Enterprise camera shoots up to 4K30fps video and 12-megapixel photos, supports shooting modes such as Single shot, Burst shooting, Interval, and Enhanced HDR. Mavic 2 Enterprise supports 2x optical zoom and 3x digital zoom when recording video in 1080p24/25/30.

The Mavic 2 Enterprise Dual features a FLIR longwave infrared thermal camera and a visual camera, providing both infrared and visible light imaging simultaneously. The FLIR longwave infrared thermal camera provides high-sensitivity (<50 mK). The visual camera uses a 1/2.3" CMOS sensor, the lens is 24 mm (35 mm format equivalent), and focus at 0.5 m to infinity. The Mavic 2 Enterprise Dual shoots up to 4K 30fps video and 12-megapixel photos, supports shooting modes such as Single shot, Burst shooting, and Interval.



- Ensure the temperature and humidity is suitable for the camera during usage and storage.
 - Use a lens cleanser to clean the lens to avoid damage.
 - DO NOT block any ventilation holes on the camera as the heat generated may damage the device and hurt the user.
-

Storing the Photos and Videos

The Mavic 2 Enterprise series comes with 24 GB of internal storage to store photos and videos. To protect your data and ensure secure access to your device, you can enable password protection.

A microSD card is also supported to store your photos and videos. A UHS-I Speed Grade 3 rating microSD card is required due to the fast read and write speeds necessary for high-resolution video data.

After enabling Add Timestamp and GPS Info in the camera settings on the DJI Pilot app, you will be able to view the time and date that images or videos are taken.



- Do not remove the microSD card from the aircraft while it is turned on. Otherwise, the microSD card may be damaged.
 - To ensure the stability of the camera system, single video recordings are limited to 30 minutes.
 - Check camera settings before use to ensure they are configured as desired.
 - Before shooting important pictures or videos, shoot a few images to test the camera is operating correctly.
 - Photos or videos cannot be transmitted or copied from the camera if the Intelligent Flight Battery is powered off.
 - Be sure to power off the Intelligent Flight Battery correctly. Otherwise, your camera parameters will NOT be saved and any recorded videos may be damaged. Note: Regardless of the reason, DJI is not responsible for any failure of an image or video to be recorded or having been recorded in a way that is not machine-readable.
 - For Mavic 2 Enterprise Dual, only the photos and videos recorded by the visual camera will have the Timestamp and GPS Info.
-

Two photos or videos will be saved simultaneously for the Mavic 2 Enterprise Dual, and the photo or video varies based on the display mode.

| Display Mode | Photo | Video |
|--------------|---------------|---------------|
| Thermal | Visible + IR | Visible + IR |
| Visible | Visible + MSX | Visible + MSX |
| MSX | Visible + MSX | Visible + MSX |

Video Edit

Mavic 2 Enterprise supports MP4 and MOV video formats, providing H.264 code formats.

Mavic 2 Enterprise Dual supports MP4 and MOV video formats, providing H.264 code formats, and supports capturing of visible light, thermal imaging, or a combination of them.

The software below has been tested by DJI and is recommended for playing or editing videos.

| Software | Mac Version | Win Version |
|---------------------------|-----------------|--------------|
| Adobe Premier Pro CC 2018 | v12.1.1 (10) | v12.1.1 (10) |
| Davinci Resolve | v15.0 free | v14.3 Studio |
| Apple Final Cut Pro X | v10.4.3 | N/A |
| Apple QuickTime | v10.4 (928.5.1) | N/A |
| Apple iMovie | v10.4.2 | N/A |
| VLC Player | v3.0.2 | v3.0.2 |

DJI AirSense

Manned aircraft with an ADS-B transceiver will actively broadcast flight information including location, flight path, speed, and altitude. DJI AirSense receives this by ADS-B transceivers via an on-board receiver or internet connection. UAVs installed DJI AirSense can obtain the position, orientation and velocity information from the manned airplane built-in ADS-B transmitter (1090 ES and UAT standard supported), calculate the collision risk level real time and send the warning to user. The system will analyze the potential risk of collision by comparing the location of a manned aircraft, sending timely warnings to pilots via the DJI Pilot app.

DJI AirSense provides users with information about nearby manned aircraft to ensure flight safety. The system doesn't actively control the drone to avoid incoming aircraft. Always fly your aircraft within a visual line of sight and be cautious at all times. Lower your altitude when you receive warnings. Please be aware that DJI AirSense has the following limitations:

1. It can only receive messages sent by manned aircraft installed with an ADS-B out device and in accordance with 1090ES (RTCA DO-260) or UAT (RTCA Do-282) standards. DJI devices will not receive related broadcast messages or send out warnings for manned aircraft without ADS-B outs or with malfunctioning ADS-B outs.
2. If there is an obstacle or steel structure between civil and DJI aircraft, the system won't be able to receive ADS-B messages sent by manned aircraft or send out warnings. Keenly observe your surroundings and fly with caution.
3. Warnings may be sent with delay when the DJI AirSense is interfered by the surrounding. Keenly observe your surroundings and fly with caution.
4. Warnings are not sent when a DJI aircraft is unable to determine its location.
5. It cannot receive ADS-B messages sent by manned aircraft or send out warnings when disabled or misconfigured.

On the precondition that connection between a DJI aircraft and the pilot remote controller is stable, when the system confirms the possibility of a collision, it will send a series of warnings based on the distance between drone and manned aircraft. We recommended that the operator descend altitude immediately after the first warning to avoid a collision, choosing another flight path where necessary.

Warning Escalation:

The first (or "lowest") level warning occurs when the manned aircraft is detected. All detected aircraft will be displayed in the app (up to 10 aircraft at a time). Please pay attention to ensure flight safety.

The second (or "middle") level warning occurs two kilometers away from the manned aircraft. Please pay attention to avoid any hazards.

The third (or "highest") level warning occurs one kilometer away from the manned aircraft. Please avoid the manned aircraft immediately.



Blue: The first level warning



Yellow: The second level warning



Red: The third level warning

Modular Accessories

Mavic 2 Enterprise series features an extended port, which allows users to mount additional DJI modular accessories onto the aircraft. Compatible DJI accessories consist of the following:

M2E Beacon: Enables aircraft identification during flight at night or in low light areas.

M2E Spotlight: Used for long-range illumination and searches in low light conditions, assisting the camera to shoot at night.

M2E Speaker: Used for long-range, real-time broadcasting or audio playback.



M2E Beacon

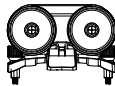

M2E Spotlight

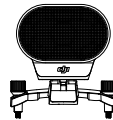

M2E Speaker

Usage

The following example illustrates how to install and use the modular accessories. Please note, for the purpose of this illustration we will use the M2E Beacon.

1. Remove the extended port cover on top of the aircraft. Make sure it is stored in a safe place for future use.
2. Mount the Beacon onto the extended slot of the aircraft.
3. Tighten the knobs on both sides to ensure that the Beacon is firmly mounted onto the aircraft.

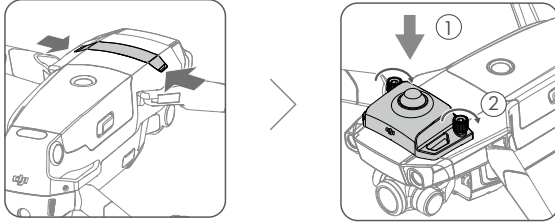

4. Power on the aircraft, and then launch the DJI Pilot app to use the Beacon.



- The Auxiliary Bottom Light can be used as a beacon. You can simply enter Visual Navigation Settings and select Bottom Auxiliary Light as Night Light in DJI Pilot.



- Make sure that the accessories are correctly and securely mounted on the aircraft before using the accessories. This is to prevent the accessory from falling off during flight.
 - DO NOT point the Spotlight or the Beacon directly at the human eye.
 - DO NOT use the Speaker near people or in an urban area where noise-sensitive structures are concentrated as the loudness could cause injuries or danger.
-

Remote Controller

This section describes the features of the remote controller and includes instructions for controlling the aircraft and the camera.

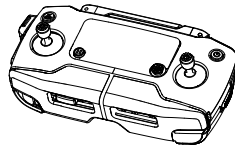

Remote Controller

Built into the remote controller is DJI's long-range transmission technology OcuSync 2.0, offering a maximum transmission range of 6.2 mi (10 km) and displaying video from the aircraft to DJI Pilot on your mobile device at up to 1080p. Easily control the aircraft and camera using the onboard buttons. An onboard LCD screen gives real-time aircraft data information and the detachable control sticks make the remote controller easier to store.

In a wide-open area with no electromagnetic interference, OcuSync 2.0 smoothly transmits video links at up to 1080p, no matter how the flight attitude is changed. The remote controller works at both 2.4 GHz and 5.8 GHz, automatically selecting the best transmission channel. OcuSync 2.0 reduces the latency to 120-130 ms by improving the camera performance through the video decoding algorithm and the wireless link.

By pressing the Focus/Shutter Button halfway, auto Focus is supported during shooting even in low light conditions. The Mavic 2 Enterprise supports zoom in/out by using the Zoom Adjustment Dial and the Mavic 2 Enterprise Dual supports exposure adjustment by using the EV Adjustment Dial.

The built-in battery has a capacity of 3950 mAh and a maximum run time of 2 hours and 15 minutes. The remote controller charges the mobile device with a charging ability of 500 mA@5V. The remote controller automatically charges Android devices. For iOS devices, first be sure that charging is enabled in DJI Pilot. Charging for iOS devices is disabled by default and needs to be enabled each time the remote controller is powered on.

Using the Remote Controller

Press the Power button to display the current battery level on the LCD screen. Press once, then again, and hold to turn the remote controller on or off.

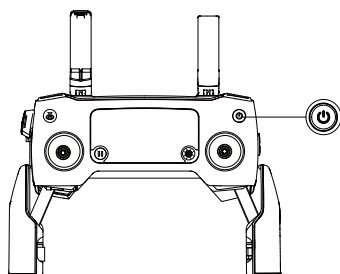

Charging the Battery

Connect the provided AC power adapter to the power port on the remote controller. It takes approximately 2 hours and 15 minutes to charge the remote controller battery fully. Remove the RC cable from the remote controller before charging.

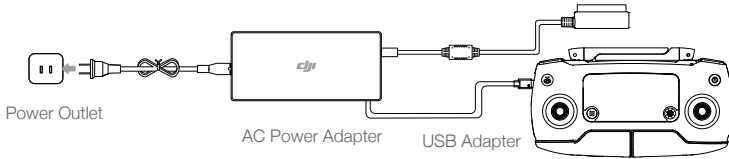

Controlling the Camera

1. Use the Record button to start/stop recording.
2. Use the Focus/Shutter Button to auto focus and take photos.
3. Use the Zoom Adjustment Dial to zoom in/out. (Mavic 2 Enterprise)
Use the EV Adjustment Dial to adjust the exposure value. (Mavic 2 Enterprise Dual)

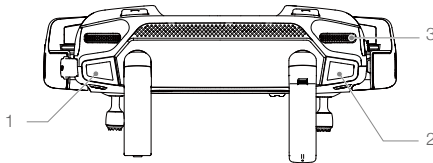

Controlling the Aircraft

The control sticks control the aircraft's orientation (yaw), forward/ backward movement (pitch), altitude (throttle), and left/right movement (roll). The control stick mode determines the function of each control stick movement. Three preprogrammed modes (Mode 1, Mode 2, and Mode 3) are available and custom modes can be configured in DJI Pilot. The default mode is Mode 2.

In each of the three pre-programmed modes, the Mavic 2 hovers in place at a constant orientation when both sticks are centered. Pushing a control stick away from the center position performs the functions shown in the figure below.

Mode 1

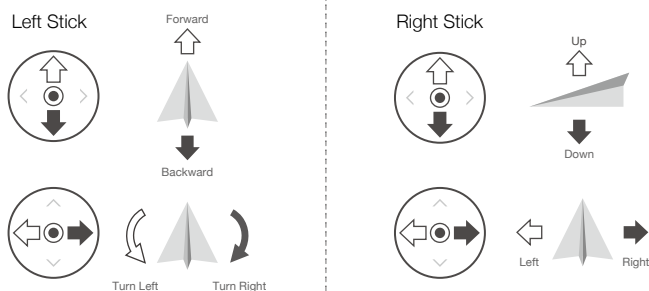



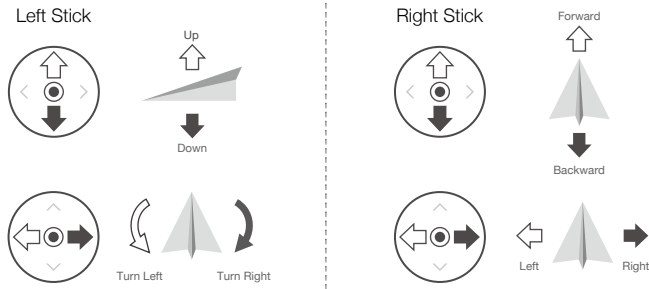

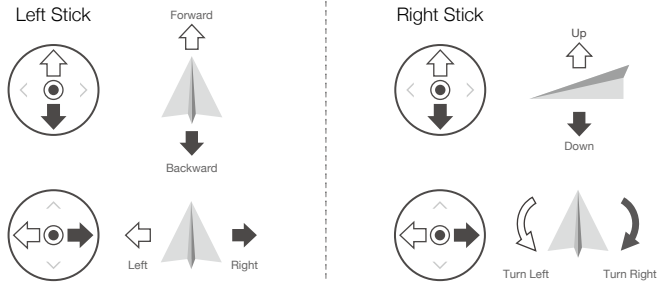

Mode 2

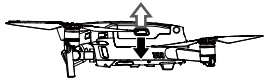

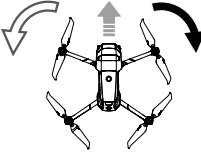
Mode 3

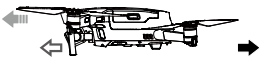
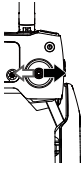

| Remote Controller (Mode 2) | Aircraft (◀▶ Indicates Nose Direction) | Remarks |
|--|--|--|
|  |  | <p>Moving the left stick up or down changes the aircraft's altitude. Push the stick up to ascend and down to descend. The more the stick is pushed away from the center position, the faster the aircraft will change altitude. Always push the stick gently to prevent sudden and unexpected changes in altitude.</p> |
|  |  | <p>Moving the left stick to the left or right controls the orientation of the aircraft. Push the stick left to rotate the aircraft counter-clockwise and right to rotate the aircraft clockwise. The more the stick is pushed away from the center position, the faster the aircraft will rotate.</p> |
|  |  | <p>Moving the right stick up and down changes the aircraft's pitch. Push the stick up to fly forward and down to fly backward. The more the stick is pushed away from the center position, the faster the aircraft will move.</p> |
|  |  | <p>Moving the right stick to the left or right changes the aircraft's roll. Push the stick left to fly left and right to fly right. The more the stick is pushed away from the center position, the faster the aircraft will move.</p> |





It is recommended to remove the control sticks and store in the storage slots on the remote controller during storage or transportation to avoid damage.

Flight Mode Switch

Toggle the switch to select the desired flight mode.

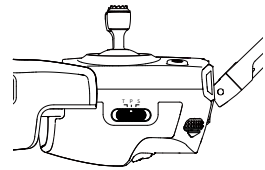
| Position | Flight Mode |
|----------|-------------|
| S | S-mode |
| P | P-mode |
| T | T-mode |



Regardless of which position the switch is in on the remote controller, the Mavic 2 Enterprise series begins in P-mode by default. To switch flight modes, first go to Camera View in DJI Pilot, tap  and enable “Multiple Flight Modes”. After enabling multiple flight modes, toggle the switch to P and then to S or T to switch flight modes.

RTH Button

Press and hold the RTH button to start the Return to Home (RTH) procedure where the aircraft returns to the last recorded Home Point. Press this button again to cancel RTH and regain control of the aircraft. Refer to the Return to Home section for more information about RTH.

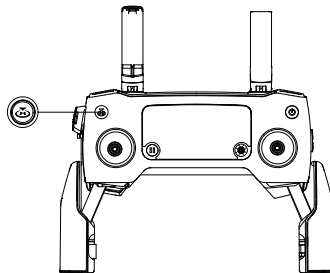

C1 and C2 Button

The functions of the C1 and C2 buttons are set in DJI Pilot. The default configuration for the C1 button is Center Focus and the default configuration for the C2 button is Playback.

Remote Controller Alert

The remote controller sounds an alert during RTH or when the battery level is low (6% to 15%). The RTH and low battery alert level can be cancelled by pressing the power button. The critical battery level alert (less than 6%), however, can not be cancelled.

Optimal Transmission Zone

The signal between the aircraft and the remote controller is most reliable when the antennas are positioned in relation to the aircraft as depicted below.

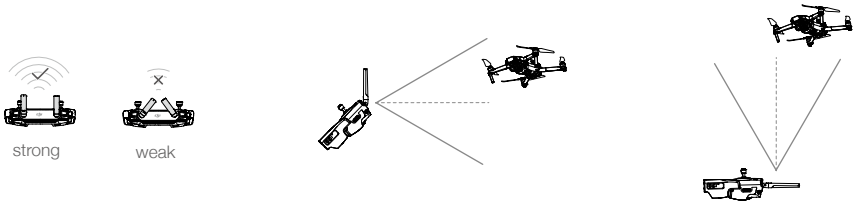

Ensure that the aircraft is flying within the optimal transmission zone. To maintain optimal transmission performance, adjust the remote controller and antennas according to the figure above.

LCD Screen

The LCD Screen displays various system statuses including real-time flight telemetry and battery levels. Refer to the figure below for the meaning of each icon on the LCD Screen.

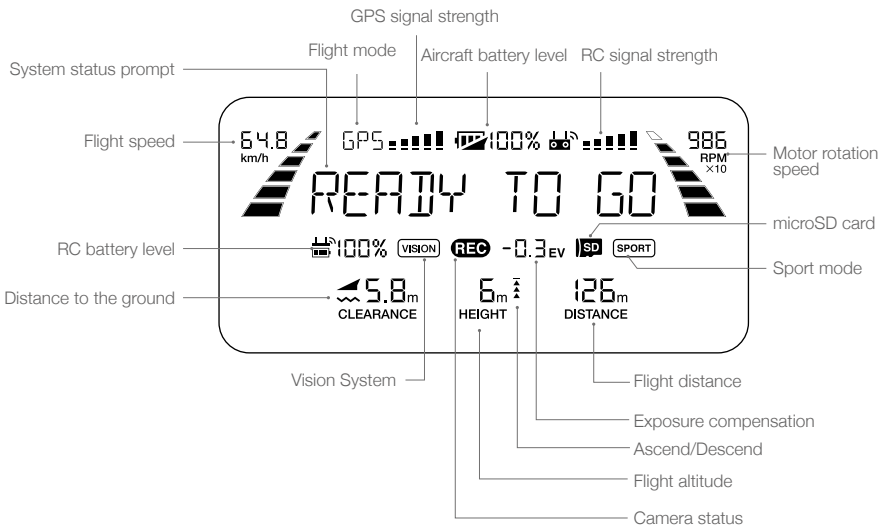

Linking the Remote Controller

The remote controller is linked to your aircraft before delivery. Linking is only required when using a new remote controller for the first time. Follow these steps to link a new remote controller:

1. Power on the aircraft and the remote controller.
2. Launch DJI Pilot.
3. Enter “Camera” and tap on  and then tap the button to confirm. The remote controller is ready to link.
4. Locate the link button on the side of the aircraft, as shown in the figure below. Press the link button to start linking. The Linking Status Indicator displays solid green once the remote controller successfully links to the aircraft, and the LCD screen on the remote controller displays the aircraft’s information.

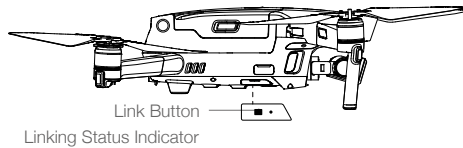

- Ensure the remote controller is within 1.6 ft (0.5 m) of the aircraft during linking.
- The remote controller will unlink itself from an aircraft if a new remote controller links to the same aircraft.



- Fully charge the remote controller before each flight.
- If the remote controller is powered on and is NOT in use for five minutes, an alert will sound. After 10 minutes, it will automatically power off. Move the sticks to cancel the alert.
- Adjust the mobile device clamp to ensure the mobile device is secure.
- Ensure the antennas of the remote controller are unfolded and adjusted to the proper position to achieve optimal transmission quality.
- Repair or replace the remote controller if damaged. A damaged remote controller antenna greatly decreases performance.
- Fully charge the battery at least once every three months to maintain battery health.
- Ensure the control sticks are mounted securely.

DJI Pilot App

This section introduces the main functions of the DJI Pilot app.

DJI Pilot App

The DJI Pilot app* is specifically developed for enterprise users. Manual flight integrates a variety of professional features that make flying simple and intuitive. Mission flight supports flight planning, and allows you to control the drone automatically, making your workflow much simpler and more efficient.



* For illustration purpose only, the DJI Pilot App in this manual is used on Android.

Manual Flight

Mavic 2 Enterprise

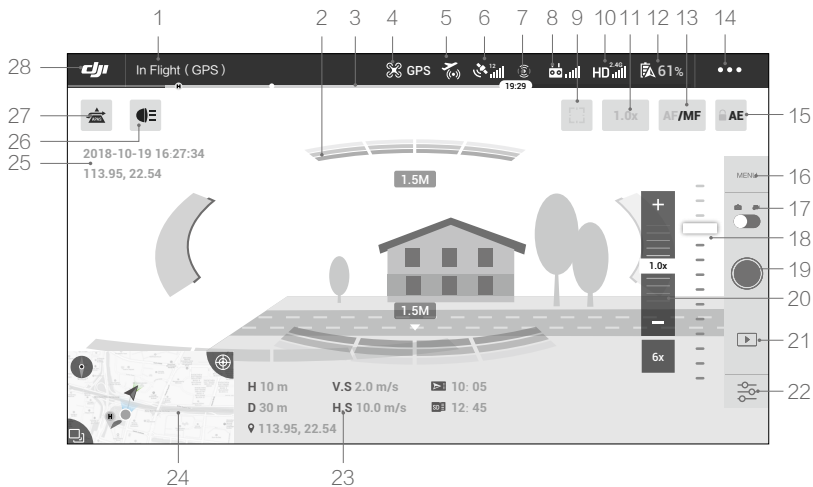

1. System Status Bar

In flight (GPS) : This icon indicates aircraft flight status and displays various warning messages.

2. Obstacle Detection Status

Red/Orange bars : Red bars are displayed when obstacles are close to the aircraft. Orange bars are displayed when obstacles are within the detection range.

3. Battery Level Indicator Bar

: The battery level indicator provides a dynamic display of the battery level. The colored zones on the battery level indicator represent the power levels needed to carry out different functions.

4. Flight Mode

: The text next to this icon indicates the current flight mode.

Tap to configure the Flight Controller settings. These settings allow you to modify flight limits and set gain values.

5. AirSense Status

: The AirSense Status displays information about nearby manned aircraft to ensure flight safety, including the distance between DJI aircraft and manned aircraft. AirSense will instruct users to land if nearby aircraft are detected.



6. GPS Signal Strength

: Shows the current GPS signal strength. White bars indicate adequate GPS strength.

7. Vision Systems Status

: Tap this button to enable or disable features provided by the Vision Systems, and it displays the status for all vision systems. The green icon indicates the corresponding vision system is available. The red icon indicates the corresponding vision system is unavailable.

8. Remote Controller Signal

: This icon shows the strength of the remote controller signal. The icon will blink when an interference is recognized during flight. When there are no additional warnings in DJI Pilot, it means that the interference will not affect operation and overall flight experience.

9. Focus/Metering Button

: Tap to switch between focus and metering mode. Tap to select object for focusing or metering. Auto Focus-Continuous will be triggered automatically according to the status of the aircraft and camera after enabling Auto Focus.

10. HD Video Link Signal Strength

HD : This icon shows the strength of the HD video downlink connection between the aircraft and the remote controller. The icon will blink when an interference is recognized during flight. When there are no additional warnings in DJI Pilot, it means that the interference will not affect operation and overall flight experience.

11. Zoom Value

1.0x: Displays the zoom value. Tap to set the value.

12. Battery Settings

61% : Shows the current battery level. Tap to view the battery information menu, set the various battery warning thresholds, and view the battery warning history.

13. AF(CF)/MF

AF/ MF : Tap to switch the focus mode.

14. General Settings

: Tap to enter the General Settings menu to set units of measurement, enable/disable livestream and more.

15. Auto Exposure Lock

AE : Tap to lock the exposure value.

16. Camera Settings

Tap to enter the photo and video settings. Tap to configure photo settings such as photo mode and image format. Tap to configure video settings such as video size and format. Tap to configure video caption, grid and smart LED settings and more.

17. Photo/Video Toggle

: Tap to switch between photo and video recording modes.

18. Gimbal Slider

: Displays the gimbal tilt angle.

19. Shoot/Record Button

: Tap to start shooting photos or recording video.

20. Manual Focus

Only effective in MF mode.

21. Playback

: Tap to enter Playback and preview photos and videos as soon as they are captured.

22. Parameter Settings

: Tap to set ISO, shutter, exposure values and other parameters.

23. Flight Telemetry

D 30 m : Distance between the aircraft and the Home Point.

H 10.0 m : Height from the Home Point.

HS 10.0 m/s : Aircraft horizontal speed.

VS 2.0 m/s : Aircraft vertical speed.

113.95, 22.54 : The longitude and latitude of the aircraft.

: Shows the remaining capacity or recording duration of the internal storage.

: Shows the remaining capacity or recording duration of the microSD card.

24. Map

Tap to view the map.



25. Time and GPS Information

Shows the current date, time and the longitude and latitude of the aircraft.

26. Accessory

Shows the connecting accessory such as the beacon , spotlight  or speaker . Tap on the screen to set the accessory.

27. Advanced Pilot Assistance System

 : Tap to enable/disable the APAS feature. The APAS feature is disabled if the Forward and Backward Vision Systems are disabled or unavailable.

28. Back

 : Tap to return to the main menu.

Mavic 2 Enterprise Dual

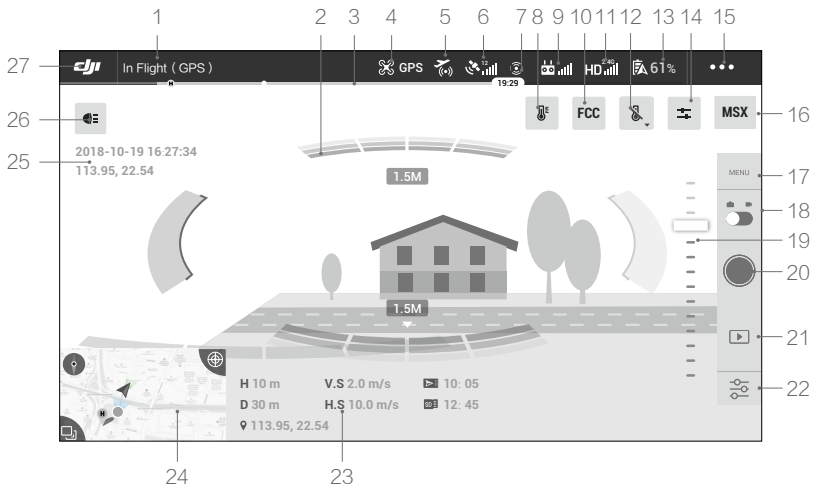

1. System Status Bar

 : This icon indicates aircraft flight status and displays various warning messages.

2. Obstacle Detection Status

 : Red bars are displayed when obstacles are close to the aircraft. Orange bars are displayed when obstacles are within the detection range.

3. Battery Level Indicator Bar

 : The battery level indicator provides a dynamic display of the battery level. The colored zones on the battery level indicator represent the power levels needed to carry out different functions.

4. Flight Mode

 : The text next to this icon indicates the current flight mode.

Tap to configure the Flight Controller settings. These settings allow you to modify flight limits and set gain values.

5. AirSense Status

 : The AirSense Status displays information about nearby manned aircraft to ensure flight safety, including the distance between DJI aircraft and manned aircraft. AirSense will instruct users to land if nearby aircraft are detected.



6. GPS Signal Strength

 : Shows the current GPS signal strength. White bars indicate adequate GPS strength.

7. Vision Systems Status

 : Tap this button to enable or disable features provided by the Vision Systems, and it displays the status for all vision systems. The green icon indicates the corresponding vision system is available. The red icon indicates the corresponding vision system is unavailable.

Isotherm and Palette

8. Isotherm and Palette

 : Isotherm

This feature allows users designate temperature ranges to be represented with different color schemes, so that objects measured in a single color scheme impart higher contrast and better visibility.

Individual isotherms (or color schemes) are separated by upper and lower thresholds.

 : Palette

The Mavic 2 Enterprise Dual offers a variety of palette options. Distinct colors are used to show temperature differences in the thermal image, which are related to grayscale intensity. The temperature range of the image is mapped to 256 colors and displayed in the 8-bit JPEG or MP4, MOV format.

The following table shows all palette options.



9. Remote Controller Signal

 : This icon shows the strength of the remote controller signal. The icon will blink when an interference is recognized during flight. When there are no additional warnings in DJI Pilot, it means that

the interference will not affect operation and overall flight experience.

10. FCC Calibration

Tap this button to enable FCC calibration in IR or MSX Mode. Calibration is used to optimize image quality. During calibration, your screen may freeze momentarily.

11. HD Video Link Signal Strength

HD: This icon shows the strength of the HD video downlink connection between the aircraft and the remote controller. The icon will blink when an interference is recognized during flight. When there are no additional warnings in DJI Pilot, it means that the interference will not affect operation and overall flight experience.

12. Temperature measurement

 : Tap to enable/disable the temperature measurement. Spot meter and Area measurement are available when using IR or MSX modes.

 Spot Meter: The temperature of any position in an image can be measured with an accuracy of $\pm 10\%$ in Low Gain Mode, and an accuracy of $\pm 5\%$ in High Gain Mode.

 Area Measurement: Enabling this function will display the average temperature, lowest temperature, highest temperature, and the corresponding locations of each area.

The temperature measurement accuracy is affected by various factors:

- 1) Reflectivity of objects - shiny metals with high reflectivity will reflect more of the background radiation and result in lower accuracy, whereas objects with matte surfaces will produce a higher accuracy.
- 2) Temperature of background radiation - a sunny day without clouds will have less of an effect on the accuracy than a cloudy day.
- 3) Air temperature and humidity - as temperature and humidity increases, accuracy decreases.
- 4) Distance between camera and object - as distance decreases, accuracy increases.
- 5) Emissivity of objects – emissivity and accuracy increase together.

13. Battery Settings

 **61%** : Shows the current battery level. Tap to view the battery information menu, set the various battery warning thresholds, and view the battery warning history.

14. MSX adjustment

 : When MSX Mode is selected, adjust the accuracy of the MSX footage using MSX adjustment.

15. General Settings

 : Tap to enter the General Settings menu to set units of measurement, enable/disable livestream and more.

16. Display Mode



Tap to switch between the Visible, IR, and MSX display modes.

Visible mode: Only displays the footage that visual camera captures.

IR mode: Only displays the footage that infrared thermal camera captures.

MSX mode: Combines the infrared and visual footage.

17. Camera Settings

Tap to enter the photo and video settings. Tap  to configure photo settings such as photo mode and image format. Tap  to configure video settings such as video size and format. Tap  to configure video caption, grid and smart LED, ROI, temperature alert, gain modes settings and more.

ROI (Region of Interest)

Use this feature to manage color range distribution across the screen to maximize contrast for regions of highest interest.

Select "Full" to evenly distribute the color spectrum across the entire image.

For instance, if there is a large patch of sky (relatively low temperature) in your image, much of the color spectrum will be allocated to the lower range, meaning that other parts of the spectrum will have a lower contrast. In this case, you may select "Sky excluded (33%)" or "Sky excluded (50%)" to ignore areas of the sky so that most of the spectrum can be allocated to remaining areas, providing higher contrast and utility for analysis.



ROI set to "Full"



Sky excluded from ROI

Temperature Alert

After enabling the Area measurement feature, an alert temperature value can be set. When the highest temperature in the selected area exceeds the alert value, an onscreen notification will appear in DJI Pilot.

Gain Modes

High Gain mode: A narrower temperature range can be captured with a higher sensitivity to temperature differences.

Low Gain mode: A wider temperature range can be captured with a lower sensitivity to temperature differences.

Auto Gain mode (default): The optimal temperature range is automatically selected according to the temperature range of the image.

18. Photo/Video Toggle

: Tap to switch between photo and video recording modes.

19. Gimbal Slider

: Displays the gimbal tilt angle.

20. Shoot/Record Button

: Tap to start shooting photos or recording video.

21. Playback

: Tap to enter Playback and preview photos and videos as soon as they are captured.

22. Parameter Settings

: Tap to set ISO, shutter, exposure values and other parameters.

23. Flight Telemetry

D 30 m : Distance between the aircraft and the Home Point.

H 10.0 m : Height from the Home Point.

HS 10.0 m/s : Aircraft horizontal speed.

VS 2.0 m/s : Aircraft vertical speed.

📍 113.95, 22.54 Coordinate: The longitude and latitude of the aircraft.

🔋 : Shows the remaining capacity or recording duration of the internal storage.

📄 12:45 : Shows the remaining capacity or recording duration of the microSD card.

24. Map

Tap to view the map.



25. Time and GPS Information

Shows the current date, time and the longitude and latitude of the aircraft. Only available in Visible mode.

26. Accessory

Shows the connecting accessory such as the beacon **📶**, the spotlight **☑** or the speaker **🔊**; tap to use or set.

27. Back

DJI : Tap to return to the main menu.

Mission Flight (Only DJI Pilot App on Android is supported)

Tap to enter the mission library. Set a waypoint flight path, define waypoint actions then start flying with a tap.

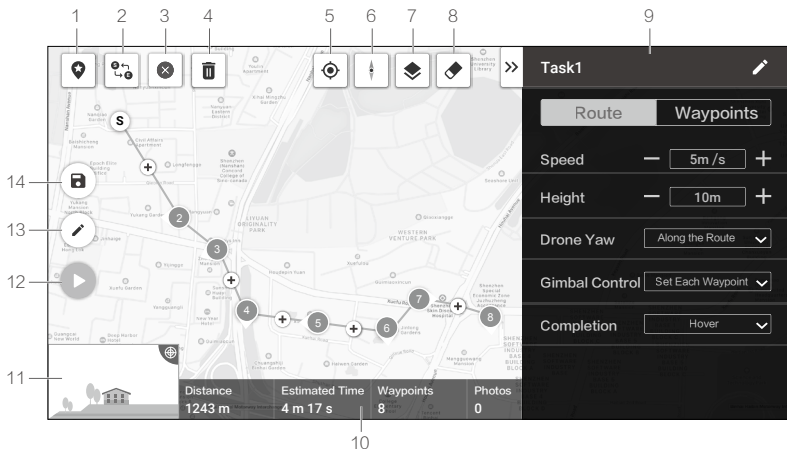

Tap on the map to add waypoints, then configure route and waypoints settings.

1. Point of Interest (POI)

📍 : Tap to enable the POI function and a POI will be displayed on the map. Drag to adjust its

position. When the POI function is enabled, the drone yaw can be set to center to POI so that the aircraft nose points at the POI during the mission. Tap this icon again to disable the POI function.

2. Reverse Path

 : Tap it to swap the start and end points to reverse the flight path. "S" refers to the start point.

3. Clear Waypoints

 : Tap to clear all the added waypoints.

4. Delete Selected Waypoint

 : Tap to delete the selected waypoint.

5. Location

 : Tap to center the map around the aircraft's location.

6. Map Lock

 : Map rotation is locked by default. North is at the top. Tap the button to unlock rotation. Then users can adjust the map orientation by tapping and rotating two fingers on the map.

7. Map Mode

 : Tap to switch between Standard and Satellite mode.

8. Clear Screen

 : Tap to clear the flight path currently shown on the map.

9. Parameter List

Edit the mission name and configure Route and Waypoints settings in the list.

Route

The settings are applied to the entire route, including aircraft speed, height, yaw, gimbal control, and completion action.

Drone Yaw:

- a. Along the route: The aircraft's nose is always aligned to the direction of the next two waypoints.
- b. Manual: Users manually control the aircraft heading using the control sticks.
- c. Set Each Waypoint: Set aircraft heading at each waypoint in "Waypoints" settings.
- d. Center to POI: This option will be displayed when a POI is added. The aircraft's now is always pointing at the POI.

Gimbal Control:

- a. Manual: Users manually control the gimbal angle through the gimbal dial.
- b. Set Each Waypoint: Set gimbal pitch angle at each waypoint in "Waypoints" settings.

Waypoints

The settings are applied to the selected waypoint, including aircraft height, yaw, rotation, gimbal pitch, and waypoint actions.

Select a waypoint and then set waypoint parameters. Tap "<" or ">" to switch to the previous or next waypoint.

Height:

- a. Follow Route: The aircraft height will be set according to "Route" settings.
- b. Defined: Input a custom height value.

Drone Yaw, Aircraft Rotation: These two options will be available to set the aircraft heading at the selected waypoint and the aircraft rotation direction when flying to the next waypoint if "Set Each Waypoint" is set for "Drone Yaw" in "Route" settings.

Gimbal Pitch: This option will be available to set the gimbal pitch angle if “Set Each Waypoint” is set for “Gimbal Control” in “Route” settings.

Actions:

Tap to enter the action list. Tap + to add the desired waypoint action and set its corresponding parameters. Tap and hold the icon  on the left of the added action, drag it to re-order the actions. To delete the action, swipe it to the left and choose an option.

10. Mission Information

Shows the flight length, estimated flight time, waypoint quantity, and photo quantity.

11. Camera Preview

The real-time camera view will be shown here once the aircraft is connected.

12. Perform

 : Tap the button and then check the settings and status of the aircraft in the pop-up checklist. Tap the “Start to Fly” button to perform the mission.

13. Edit

 : If the path is not in edit mode, tap the icon to enter edit mode to edit the mission.

14. Save

 : Tap to save current settings.

Album

View your masterpieces all in one place. You can save the photos or videos to your mobile device.

DJI FlightHub

DJI FLIGHTHUB™ is a web-based drone management platform that provides users with real-time monitoring, flight logs and data, team management and more.

For more information, please visit www.dji.com/flighthub



- Be sure to fully charge your mobile device before launching DJI Pilot.
- Mobile cellular data is required when using DJI Pilot. Please contact your wireless carrier for data charges.
- If you are using a phone as your mobile display device, DO NOT accept phone calls or use the texting features during flight.
- Read all safety tips, warning messages, and disclaimers carefully. Be familiar with the related regulations in your area. You are solely responsible for being aware of all relevant regulations and flying in a way that is compliant.
 - a. Read and understand the warning messages before using the Auto-take off and Auto-landing features.
 - b. Read and understand the warning messages and disclaimer before setting the altitude beyond the default limit.
 - c. Read and understand the warning messages and disclaimer before switching between flight modes.
 - d. Read and understand the warning messages and disclaimer prompts near or in no-fly zones.
- Land your aircraft immediately at a safe location if an alert shows on the app.
- Review all warning messages on the checklist displayed in the app before each flight.
- Cache the map data of the area where you intend to fly the aircraft by connecting to the internet before each flight.
- The app is designed to assist your operation. Please use your sound discretion and DO NOT rely on the app to control your aircraft. Your use of the app is subject to DJI Pilot Terms of Use and DJI Privacy Policy. Please read them carefully in the app.

Flight

This section describes safe flight practices and flight restrictions.

Flight

Once pre-flight preparation is complete, it is recommended to use the flight simulator in DJI Pilot to hone your flight skills and practice flying safely. Ensure that all flights are carried out in an open area. Refer to the Remote Controller and DJI Pilot sections for information about using the remote controller and the app to control the aircraft.

Flight Environment Requirements

1. Do not use the aircraft in severe weather conditions including wind speeds exceeding 10 m/s, snow, rain, and fog.
2. Fly in open areas. Tall structures and large metal structures may affect the accuracy of the onboard compass and GPS system.
3. Avoid obstacles, crowds, high voltage power lines, trees, and bodies of water.
4. Minimize interference by avoiding areas with high levels of electromagnetism such as locations near power lines, base stations, electrical substations, and broadcasting towers.
5. Aircraft and battery performance is subject to environmental factors such as air density and temperature. Be very careful when flying 19685 ft (6000 m) or more above sea level, since battery and aircraft performance may be reduced.
6. The Mavic 2 cannot use GPS within the polar regions. Use the Downward Vision System when flying in such locations.

Flight Limits and GEO Zones

Abide by all laws and regulations when flying your Mavic 2 Enterprise series. Flight limitations are applied by default to help users operate this product safely and legally. Flight limitations include altitude limits, distance limits, and GEO Zones.

Altitude limits, distance limits, and GEO Zones function concurrently to manage flight safety when operating in P-mode.

Flight Altitude and Distance Limits

The flight altitude and distance limits may be changed in DJI Pilot. The maximum flight altitude setting cannot exceed 1640 ft (500 m). Based on these settings, the aircraft will fly in a restricted cylinder, as shown below:

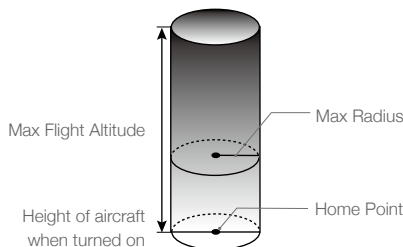

| GPS Signal Strong  Blinking Green | | | |
|--|--|----------------------------------|---------------------------|
| | Flight Limits | DJI Pilot App | Aircraft Status Indicator |
| Max Altitude | Aircraft's altitude cannot exceed the specified value. | Warning: Height limit reached. | N/A |
| Max Distance | Flight distance must be within the max radius. | Warning: Distance limit reached. | N/A |

| GPS Signal Weak  Blinking Yellow | | | |
|---|---|--------------------------------|---------------------------|
| | Flight Limits | DJI Pilot App | Aircraft Status Indicator |
| Max Altitude | Height is restricted to 16 ft (5 m) when the GPS signal is weak and Downward Vision System is activated. Height is restricted to 98 ft (30 m) when the GPS signal is weak and Downward Vision System is inactivate. | Warning: Height limit reached. | N/A |
| Max Distance | No limit | | |

-  • If the aircraft reaches one of the limits, you can still control the aircraft, but you cannot fly it any farther.
- If the aircraft flies out of the max radius, it will fly back within range automatically when the GPS signal is strong.
- For safety reasons, please do not fly close to airports, highways, railway stations, railway lines, city centers, or other sensitive areas. Fly the aircraft only within your line of sight.

GEO Zones

All GEO Zones are listed on the DJI official website at <http://www.dji.com/flysafe>. GEO Zones are divided into different categories and include locations such as airports, flying fields where manned aircraft operate at low altitudes, borders between countries, and sensitive locations such as power plants.

Pre-Flight Checklist

1. Ensure the remote control device, mobile device, and Intelligent Flight Battery are fully charged.
2. Ensure the Intelligent Flight Battery and the propellers are mounted securely.
3. Ensure the aircraft arms and propellers are unfolded.
4. Ensure the gimbal and camera are functioning normally.
5. Ensure that there is nothing obstructing the motors and that they are functioning normally.
6. Ensure that DJI Pilot is successfully connected to the aircraft.
7. Ensure that the camera lens and Vision System sensors are clean.

8. Make sure that the accessories are correctly and securely mounted on the aircraft before using it.
9. Use only genuine DJI parts or parts certified by DJI. Unauthorized parts or parts from non-DJI certified manufacturers may cause system malfunctions and compromise safety.

Starting/Stopping the Motors

Starting the Motors

A Combination Stick Command (CSC) is used to start the motors. Push both sticks to the inner or outer bottom corners to start the motors. Once the motors have started spinning, release both sticks simultaneously.

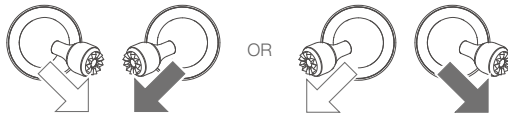

Stopping the Motors

There are two methods to stop the motors:

Method 1: When the aircraft has landed, push and hold the left stick down. The motors stop after three seconds.

Method 2: When the aircraft has landed, conduct the same CSC that was used to start the motors, as described above. The motors stop immediately. Release both sticks once the motors have stopped.

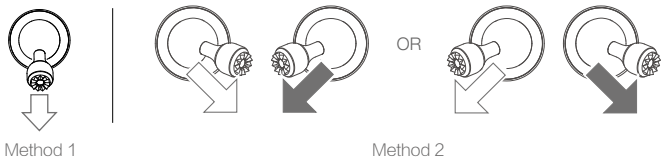

Stopping Motors Mid-Flight

Stopping the motors mid-flight will cause the aircraft to crash. The motors should only be stopped mid-flight in an emergency situation such as if there is a collision, a motor has stalled, the aircraft is rolling in the air, or the aircraft is out of control and is ascending/descending very quickly. To stop the motors mid-flight, use the same CSC that was used to start the motors.

Test Flight

Takeoff/Landing Procedures

1. Place the aircraft in an open, flat area with the Aircraft Status Indicator facing towards you.
2. Turn on the aircraft and the remote controller.
3. Launch DJI Pilot and enter Camera View.
4. Wait until the Aircraft Status Indicator blinks green indicating that the Home Point has been recorded and it is now safe to fly.
5. Push the throttle stick up slowly to take off.
6. To land, hover over a level surface and gently pull down on the throttle stick to descend.
7. After landing, hold the throttle stick at its lowest position until the motors stop.
8. Turn off the Intelligent Flight Battery first, then the remote controller.

Video Suggestions and Tips

1. The pre-flight checklist is designed to help you fly safely and to ensure that you can shoot video during flight. Go through the full pre-flight checklist before each flight.
2. Select the desired gimbal operation mode in DJI Pilot.
3. Only shoot video when flying in P-mode or T-mode.
4. DO NOT fly in bad weather conditions such as when it is raining or windy.
5. Choose the camera settings that best suit your needs. Settings include photo format and exposure compensation.
6. Perform flight tests to establish flight routes and to preview scenes.
7. Push the control sticks gently to keep the aircraft movement smooth and stable.

Appendix

Appendix

Specifications

| Aircraft | |
|--------------------------------------|--|
| Takeoff Weight (Without Accessories) | 905 g (Mavic 2 Enterprise); 899 g (Mavic 2 Enterprise Dual) |
| Max Takeoff Weight | 1100 g |
| Dimensions | Folded: 214×91×84 mm (length×width×height) Unfolded: 322×242×84 mm (length×width×height) |
| Diagonal Distance | 354 mm |
| Max Ascent Speed | 5 m/s (S-mode), 4 m/s (P-mode) |
| Max Descent Speed | 3 m/s (S-mode), 3 m/s (P-mode) |
| Max Speed | 72 km/h (S-mode) (near sea level, no wind) |
| Max Service Ceiling Above Sea Level | 6000 m |
| Max Flight Time | 31 minutes (at a consistent 25 kph, no wind) |
| Max Hovering Time | 29 min (no wind) 27 min (with beacon turned on) 28 min (with beacon turned off) 22 min (with spotlight turned on) 26 min (with spotlight turned off) 25 min (with speaker turned on) 26 min (with speaker turned off) |
| Overall Flight Time | 25 minutes (in normal flight, 15% remaining battery level) |
| Max Flight Distance | 18 km (at a consistent 50 kph, no wind) |
| Max Wind Speed Resistance | 29–38 kph |
| Max Tilt Angle | 35° (S-mode, with remote controller), 25° (P-mode) |
| Max Angular Velocity | 200°/s |
| Operating Temperature Range | -10°C - 40°C |
| GNSS | GPS+GLONASS |
| Hovering Accuracy Range | Vertical: ±0.1 m (when vision positioning is active) ±0.5 m (with GPS positioning) Horizontal: ±0.3 m (when vision positioning is active) ±1.5 m (with GPS positioning) |
| Operating Frequency | 2.400 - 2.4835 GHz; 5.725 - 5.850 GHz |
| Transmission Power (EIRP) | 2.4 GHz FCC: ≤26 dBm; CE: ≤20 dBm; SRRC: ≤20 dBm; MIC: ≤20 dBm 5.8 GHz FCC: ≤26 dBm; CE: ≤14 dBm; SRRC: ≤26 dBm |
| Internal Storage | 24 GB |
| Gimbal | |
| Mechanical Range | Tilt: -135 to 45°, Pan: -100 to 100°, Roll: -45 to 45° |

| | |
|------------------------------------|---|
| Controllable Range | Tilt: -90 to 30°, Pan: -75 to 75° |
| Stabilization | 3-axis (tilt, roll, pan) |
| Max Control Speed (tilt) | 120°/s |
| Angular Vibration Range | ±0.005° (Mavic 2 Enterprise); ±0.01° (Mavic 2 Enterprise Dual) |
| Sensing System | |
| Sensing System | Omnidirectional Obstacle Sensing |
| FOV | Forward: Horizontal: 40°, Vertical: 70° Backward: Horizontal: 60°, Vertical: 77° Downward: Front and Back: 100°, Left and Right: 83° Lateral: Horizontal: 80°, Vertical: 65° |
| Obstacle Sensing Range | Forward: Precision Measurement Range: 0.5 - 20 m Detectable Range: 20 - 40 m Effective Sensing Speed: ≤ 14 m/s Backward: Precision Measurement Range: 0.5 - 16 m Detectable Range: 16 - 32 m Effective Sensing Speed: ≤ 12 m/s Upward: Precision Measurement Range: 0.1 - 8 m Downward: Precision Measurement Range: 0.5 - 11 m Detectable Range: 11 - 22 m Sides: Precision Measurement Range: 0.5 - 10 m Effective Sensing Speed: ≤ 8 m/s |
| Operating Environment | Surface with clear pattern and adequate lighting (lux >15) Detects diffuse reflective surfaces (>20%) (walls, trees, people, etc.) |
| Velocity Range | ≤31mph (50 kph) at 6.6 ft (2 m) above ground |
| Altitude Range | 0.1 - 11 m |
| Operating Range | 0.3 - 50 m |
| Camera (Mavic 2 Enterprise) | |
| Sensor | 1/2.3" CMOS Effective Pixels: 12 million |
| Lens | FOV: approx. 83° (24 mm) approx. 48° (48 mm) 35 mm Format Equivalent: 24-48 mm Aperture: f/2.8 (24 mm)–f/3.8 (48 mm) Shooting Range: 0.5 m to ∞ |
| ISO Range | Video: 100-3200 Photo: 100-1600 (auto) 100-12800 (manual) |
| Shutter Speed | Electronic Shutter: 8–1/8000 s |
| Still Image Size | 4000×3000 |
| Still Photography Modes | Single shot Burst shooting: 3/5/7 frames Auto Exposure Bracketing (AEB): 3/5 bracketed frames at 0.7 EV Bias Interval (JPEG): 2/3/5/7/10/15/20/30/60s RAW: 5/7/10/15/20/30/60s) |
| Video Resolution | 4K: 3840×2160 24/25/30p 2.7K: 2688×1512 24/25/30/48/50/60p FHD: 1920×1080 24/25/30/48/50/60/120p |
| Max Video Bitrate | 100 Mbps |

| | |
|---|--|
| Supported File System | FAT32: ≤ 32 GB exFAT: > 32 GB |
| Photo Format | JPEG / DNG (RAW) |
| Video Format | MP4 / MOV (MPEG-4 AVC/H.264, HEVC/H.265) |
| Supported SD Cards | Supports a microSD with capacity of up to 128 GB. A UHS-I Speed Grade 3 rating microSD card is required. |
| Operating Temperature Range | -10°C to 40°C |
| HDR | HDR, 13 EV |
| Camera (Mavic 2 Enterprise Dual) | |
| Thermal Camera | |
| Sensor | Uncooled VOx Microbolometer |
| Lens | HFOV: 57° Aperture: f/1.1 |
| Pixel Pitch | 12 μm |
| Spectral Band | 8-14 μm |
| Image Size* | 640×480 (4:3); 640×360 (16:9) |
| Still Photography Modes | Single shot Burst shooting: 3/5/7 frames Interval (2/3/5/7/10/15/20/30/60 s) |
| Video Recording Modes | 640×360 @8.7fps |
| Accuracy | High Gain: Max ±5% (typical) Low Gain: Max ±10% (typical) |
| Scene Range | High Gain: -10° to +140°C Low Gain: -10°to +400°C |
| Supported File System | FAT32/exFAT |
| Photo | JPEG |
| Video | MP4, MOV (MPEG-4 AVC/H.264) |
| Visual Camera | |
| Sensor | 1/2.3" CMOS; Effective pixels: 12M |
| pixel pitch | 1.55 μm |
| Lens | FOV: approx. 85° 35 mm format equivalent:24 mm Aperture: f/2.8 Focus: 0.5 m to ∞ |
| ISO Range | Video: 100-12800 (auto) Photo: 100-1600 (auto) |
| Shutter Mode | Electronic shutter: auto |
| Max Image Size | 4056×3040 (4:3); 4056×2280 (16:9) |
| Still Photography Modes | Single shot Burst shooting: 3/5/7 frames Interval (2/3/5/7/10/15/20/30/60 s) |

* Due to real-time digital enhancements, the photo and video size of the thermal data is larger than the sensor's native resolution.

| | |
|-----------------------------------|---|
| Video Recording Modes | 4K Ultra HD: 3840×2160 30p 2.7K: 2688×1512 30p FHD: 1920×1080 30p |
| Max Video Bitrate | 100 Mbps |
| Supported File System | FAT32/exFAT |
| Photo | JPEG |
| Video | MP4, MOV (MPEG-4 AVC/H.264) |
| Remote Controller | |
| Operating Frequency | 2.400 - 2.4835 GHz; 5.725 - 5.850 GHz |
| Max Transmission Distance | FCC: 10 km; CE: 6 km; SRRC: 6 km; MIC: 6 km (unobstructed, free of interference) |
| Operating Temperature Range | 0°C - 40°C |
| Battery | 3950 mAh |
| Transmission Power (EIRP) | 2.400 - 2.4835 GHz FCC: ≤26 dBm; CE: ≤20 dBm; SRRC: ≤20 dBm; MIC: ≤20 dBm 5.725 - 5.850 GHz FCC: ≤26 dBm; CE: ≤14 dBm; SRRC: ≤26 dBm |
| Operating Current/Voltage | 1800 mA @ 3.83 V |
| Supported Mobile Device Size | Max length: 160 mm; max thickness: 6.5 – 8.5 mm |
| Supported USB Port Types | Lightning, Micro USB (Type-B), USB-C |
| Charger | |
| Input | 100-240 V, 50/60 Hz, 1.8 A |
| Output | Main: 17.6 V = 3.41 A or 17.0 V = 3.53 A USB: 5 V = 2 A |
| Voltage | 17.6±0.1 V or 17.0 V±0.1 V |
| Rated Power | 60 W |
| Intelligent Flight Battery | |
| Capacity | 3850 mAh |
| Voltage | 15.4 V |
| Max Charging Voltage | 17.6 V |
| Battery Type | LiPo 4S |
| Energy | 59.29 Wh |
| Net Weight | 297 g |
| Charging Temperature Range | 5°C - 40°C |
| Max Charging Power | 80 W |
| Heating Temperature Rang | -4° to 43° F (-20° to 6° C) |
| Heating Time | 600 s (max) |
| Heating Power | 35 W (max) |
| App | |
| Video Transmission System | OcuSync 2.0 |
| Name | DJI Pilot |

| | |
|---|--|
| Live View Quality | 720p@30fps / 1080p@30fps |
| Latency (depending on environmental conditions and mobile device) | 120 - 130 ms |
| Required Operating System | iOS 10.0 or later Android 5.0 or later |
| M2E Beacon | |
| Dimensions | 68×40×27.8 mm |
| Interface Type | USB Micro-B |
| Power | Avg. 1.6 W |
| Luminous Intensity | Min. Angle: 55 cd; light intensity: 157 cd |
| Max. Visible Distance | 5000 m (with good air quality and high visibility) |
| M2E Spotlight | |
| Dimensions | 68×60×41 mm |
| Interface Type | USB Micro-B |
| Power | Max. 26 W |
| Illuminance | FOV 17°, Max. 11 lux @ 30 m straight |
| Illumination area | 30 m |
| M2E Speaker | |
| Dimensions | 68×55×65 mm |
| Interface Type | USB Micro-B |
| Power | Max. 10 W |
| Decibel | 100 dB at 1 m-distance (International Standard) |
| Code Stream | 16 kbps |

Calibrating the Compass

It is recommended that the compass is calibrated in any of the following situations when flying outdoors:

1. Flying at a location farther than 31 miles (50 km) away from the location the drone was last flown.
2. The aircraft has not been flown for more than 30 days.
3. A compass interference warning appears in DJI Pilot and/or the Aircraft Status Indicators blink alternating red and yellow.

-
-  • DO NOT calibrate the compass in locations where magnetic interference may occur, such as close to magnetite deposits or large metallic structures such as parking structures, steel reinforced basements, bridges, cars, or scaffolding.
- DO NOT carry objects (such as cell phones) that contain ferromagnetic materials near the aircraft during calibration.
 - It is not necessary to calibrate the compass when flying indoors.
-

Calibration Procedure

Choose an open area to carry out the following procedure.

1. Tap the System Status Bar in DJI Pilot, select "Calibrate", and follow the on-screen instructions.
2. Hold the aircraft horizontally and rotate it 360 degrees. The Aircraft Status Indicator will turn solid green.
3. Hold the aircraft vertically, with its nose pointing downward, and rotate it 360 degrees around a vertical axis.
4. If the Aircraft Status Indicator blinks red, the calibration has failed. Change your location and try the calibration procedure again.

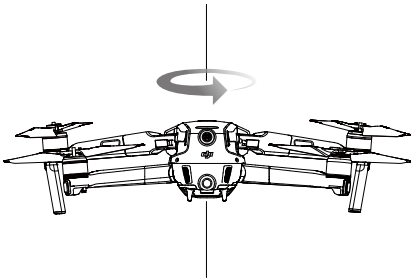

Horizontal Calibration



Vertical Calibration



- The aircraft can take off immediately once calibration is complete. If you wait more than three minutes to take off after calibration, you may need to calibrate again. It is possible that another compass interference warning will appear while the aircraft is on the ground. This indicates that the current location is not suitable for flying the aircraft, due to the level of magnetic interference.

Firmware Updates

Use DJI Pilot or DJI Assistant 2 for Mavic to update the aircraft firmware.

Using DJI Pilot

When you connect the aircraft or remote controller to DJI Pilot, you will be notified if a new firmware update is available. To start updating, connect your mobile device to the internet and follow the on-screen instructions. Note that you cannot update the firmware if the remote controller is not linked to the aircraft.

Using DJI Assistant 2 for Mavic

The USB-C port is used when connecting the aircraft to a computer to update firmware. Follow the instructions below to update the firmware through DJI Assistant 2 for Mavic:

1. With the aircraft powered off, connect the aircraft to a computer via the Micro USB port using a Micro USB cable.
2. Power on the aircraft.
3. Launch DJI Assistant 2 for Mavic and log in with your DJI account.
4. Select “Mavic 2” and click on Firmware Updates on the left panel.
5. Select the firmware version that you wish to update to.
6. Wait for the firmware to download. The firmware update will start automatically.
7. Reboot the aircraft after the firmware update is complete.

-
-  • Ensure the aircraft is connected to the computer before powering on.
- The firmware update will take around 15 minutes. It is normal that the gimbal goes limp, aircraft status indicators blink, and the aircraft reboots. Please wait patiently until the update is complete.
 - Ensure the computer has access to the Internet.
 - Before performing an update ensure the Intelligent Flight Battery has at least 50% power and the remote controller has at least 30% power.
 - Do not disconnect the aircraft from the computer during an update.
 - For safety, always update the firmware to the latest version when an update notification is shown in DJI Pilot.
 - Firmware update notifications will prompt you to proceed with an update immediately or to update the firmware within three days. If you choose to ignore the current firmware update, you are required to accept the prompted disclaimer. You further understand and agree that the data includes but is not limited to user selection records and may be uploaded to and maintained on a DJI designated server.
 - The remote control device may become unlinked from the aircraft after updating. Re-link the remote control device and aircraft.
 - Be sure to check all connections and remove the propellers from the motors before performing the firmware update. DO NOT disconnect the aircraft or remote controller from the computer or internet while updating the firmware.
-

Remote Controller LCD Screen Menu Information

| Remote Controller Status | |
|--------------------------|--|
| BAT xx PCT | Remote controller battery level. |
| SHUTDOWN_ | Remote controller is powering off. |
| CHARGING_ | Remote controller is charging. |
| USB PLUGGED | Mavic 2 has been connected to a computer. |
| FC U-DISK | Flight Controller is reading data. |
| UPGRADING | Upgrading. |
| BINDING | Aircraft is binding with the remote controller. |
| Before Flight | |
| CONNECTING_ | The remote controller is connecting to the aircraft. |
| SYS INITING | System is initiating. |
| READY TO GO | Ready to take off. |
| Flight Mode | |
| GPS MODE | In P-GPS Mode. |
| OPTI MODE | In P-OPTI Mode. |

| | |
|---|---|
| ATTI MODE | In P-ATTI Mode. |
| SPORT MODE | In Sport Mode. |
| TRIPOD | In Tripod Mode. |
| Flight Status | |
| TAKING OFF | Taking off. |
| LANDING | Landing. |
| GOING HOME | Returning to Home. |
| MAX ALT. | Aircraft has reached maximum altitude. |
| MAX RADIUS | Aircraft has reached maximum radius. |
| OBSTACLE | Obstacle detected. |
| NO FLY ZONE | Aircraft is in a No Fly zone. |
| Intelligent Flight Mode Status | |
| APAS MODE | Using APAS. |
| System Warning and Error Information | |
| SYS WARNING+CHECK APP | System Warning. See DJI Pilot for more information. |
| UNACTIVATED+CHECK APP | Aircraft not Activated. See DJI Pilot for more information. |
| MAG INTERF+CHECK APP | Compass Error. See DJI Pilot for more information. |
| BATTERY ERR+CHECK APP | Battery Error. See DJI Pilot for more information. |
| SD ERR+CHECK APP | microSD card Error. See DJI Pilot for more information. |
| CALIBRATING | IMU Calibrating/Did not restart aircraft after calibration is complete. |
| STICK ERR+RE-CTR STCK | Control stick is not centered. Re-center it. |
| WHEEL ERR+RE-CTR WHEL | Left Dial on the remote controller is not centered. Re-center it. |
| STICK ERR | Control stick error. Calibrate the control sticks in the DJI Pilot. |
| MECH ERR | Remote Controller Error. Calibrate the remote controller in the DJI Pilot. If this problem persists, contact DJI support. |
| SD FULL | microSD card is full. |
| NO PROP | No propellers attached. |
| BAT TEMP HI | Intelligent Flight Battery is too hot. |
| BATTERY ERR | Intelligent Flight Battery error. |
| BAT TEMP LO | Intelligent Flight Battery is too cold. |
| LOW BATTERY | Intelligent Flight Battery low battery. |
| RC LOW BAT | Remote controller low battery. |
| NO RC SIGNL | Remote controller signal lost. |
| RC TEMP HI | Remote controller too hot. |
| NO RTH | Aircraft cannot Return to Home. |

After-Sales Information

Visit <https://www.dji.com/support> to learn more about after-sales service policies, repair services and support.

DJI Support
<http://www.dji.com/support>

This content is subject to change.

Download the latest version from
<http://www.dji.com/mavic-2-enterprise>



If you have any questions about this document, please contact DJI
by sending a message to **DocSupport@dji.com**.

MAVIC is a trademark of DJI.
Copyright © 2021 DJI All Rights Reserved.