

# MAVIC 2 ENTERPRISE

## Advanced

### User Manual

v1.0 2021.03

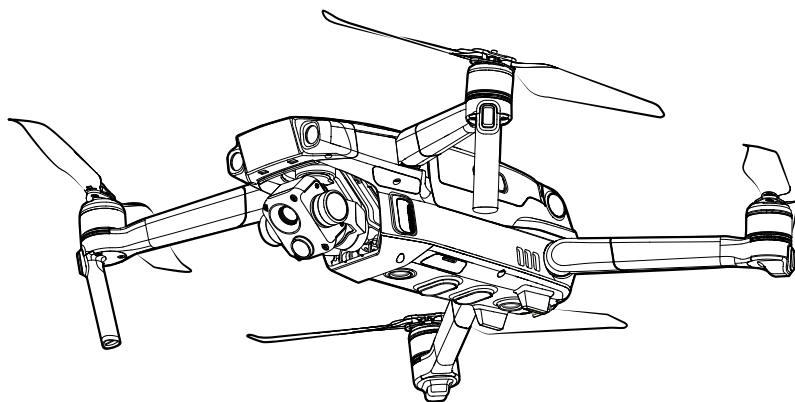

### **Searching for Keywords**

Search for keywords such as “battery” and “install” to find a topic. If you are using Adobe Acrobat Reader to read this document, press Ctrl+F on Windows or Command+F on Mac to begin a search.

### **Navigating to a Topic**

View a complete list of topics in the table of contents. Click on a topic to navigate to that section.

### **Printing this Document**

This document supports high resolution printing.

# Using This Manual

## Legend

⚠ Warning

⚠ Important

💡 Hints and Tips

📖 Reference

## Read Before the First Flight

Read the following documents before using the MAVIC™ 2 Enterprise Advanced:

1. In the Box
2. User Manual
3. Quick Start Guide
4. Disclaimer and Safety Guidelines
5. Intelligent Flight Battery Safety Guidelines

It is recommended to read the disclaimer and safety guidelines before using for the first time. Prepare for your first flight by reviewing the quick start guide and refer to this user manual for more information.

## Download the DJI Pilot App

Make sure to use the DJI Pilot app during flight.\* Mavic 2 Enterprise Advanced is only compatible with the Android version of DJI Pilot and Smart Controller.



Scan the QR code on the right to download the latest version. The Android version of DJI Pilot is compatible with Android v5.0 and later.

\* For increased safety, flight is restricted to a height of 98.4 ft (30 m) and range of 164 ft (50 m) when not connected or logged into the app during flight. This applies to DJI Pilot and all apps compatible with DJI aircraft.

## Download DJI Assistant 2 (Enterprise Series)

Download DJI ASSISTANT™ 2 (Enterprise Series) at <http://www.dji.com/mavic-2-enterprise-advanced>

---

⚠ The operating temperature of this product is -10° to 40° C. It does not meet the standard operating temperature for military grade applications (-55° to 125° C), which is required to endure greater environmental variability. Operate the product appropriately and only for applications where it meets the operating temperature range requirements of that grade.

---

# Contents

<b>Using This Manual</b>	<b>3</b>
Legend	3
Read Before the First Flight	3
Download the DJI Pilot App	3
Download DJI Assistant 2 (Enterprise Series)	3
<b>Product Profile</b>	<b>7</b>
Introduction	7
Preparing the Aircraft	7
Preparing the Remote Controller	9
Diagram	10
Activation	13
<b>Aircraft</b>	<b>15</b>
Flight Modes	15
Aircraft LEDs and Status Indicator	16
Return to Home	17
Vision Systems and Infrared Sensing Systems	20
Flight Recorder	23
Password Protection	23
Attaching and Detaching the Propellers	24
Intelligent Flight Battery	25
Gimbal and Camera	28
DJI AirSense	30
Modular Accessories	31
Using the RTK Module	32
<b>Smart Controller</b>	<b>34</b>
Smart Controller Profile	34
Smart Controller Operations	34
Linking the Smart Controller	39
Status LED and Battery Level LEDs Description	40
Smart Controller Warning Sounds	41



<b>DJI Pilot App</b>	<b>43</b>
Manual Flight	43
Mission Flight	49
Album	53
<b>Flight</b>	<b>55</b>
Flight Environment Requirements	55
Flight Limits and GEO Zones	55
Pre-Flight Checklist	57
Starting/Stopping the Motors	57
Flight Test	58
<b>Appendix</b>	<b>60</b>
Specifications	60
Calibrating the Compass	65
Updating Firmware	66
After-Sales Information	67

# Product Profile

---

This section introduces Mavic 2 Enterprise Advanced and lists the components of the aircraft and remote controller.

# Product Profile

## Introduction

DJI Mavic 2 Enterprise Advanced features omnidirectional Vision Systems and Infrared Sensing Systems, and comes with a fully stabilized 3-axis gimbal camera that includes a thermal camera and a visual camera, providing both infrared and visual images simultaneously. DJI's Obstacle Sensing technology helps users to fly safely so they can capture complex shots while DJI AirSense provides awareness of the surrounding airspace and password protection ensures access to the aircraft and all data is secure.

Boasting a fully stabilized 3-axis gimbal camera with a thermal camera and visual camera, Mavic 2 Enterprise Advanced offers infrared and visible light imaging simultaneously. The infrared thermal camera records 640x512 video, and the visual camera captures 4K videos and 48MP photos. The aircraft supports up to 32x digital zoom. Using the latest technology to reduce the angular vibration range to within +0.005, Mavic 2 Enterprise Advanced provides increased stability and footage quality.

Built into the remote controller is DJI's long-range transmission technology Ocusync™ 2.0, offering a maximum transmission range of 6.2 mi (10 km) and displaying video from the aircraft to DJI Pilot on a mobile device at up to 720p. The remote controller works at both 2.4 GHz and 5.8 GHz and can automatically select the best transmission channel without any latency. The aircraft and camera can easily be controlled using the onboard buttons. The DJI Smart Controller comes with a number of aircraft and gimbal controls as well as customizable buttons and has a built-in 5.5-inch high-brightness screen. The remote controller features Bluetooth compatibility, supports GNSS, and can connect to the internet via Wi-Fi. The detachable control sticks make the remote controller easier to store. The maximum run time is 2.5 hours.

The Mavic 2 Enterprise Advanced boasts a maximum flight speed of 44.7 mph (72 kph) and a maximum flight time of 31 minutes.

- 
- ⚠
- The maximum flight time was tested in an environment with no wind while flying at a consistent 15.5 mph (25 kph) and the maximum flight speed was tested at sea level altitude with no wind. These values are for reference only.
  - The remote controller reaches its maximum transmission distance (FCC) in a wide-open area with no electromagnetic interference at an altitude of about 400 ft (120 m). The maximum runtime was tested in a laboratory environment. This value is for reference only.
  - 5.8 GHz is not supported in certain regions. Observe local laws and regulations.
- 

## Preparing the Aircraft

All aircraft arms are folded before the aircraft is packaged. Follow the steps below to unfold the aircraft.

1. Remove the gimbal cover from the camera.
2. Unfold the front arms before unfolding the rear arms.

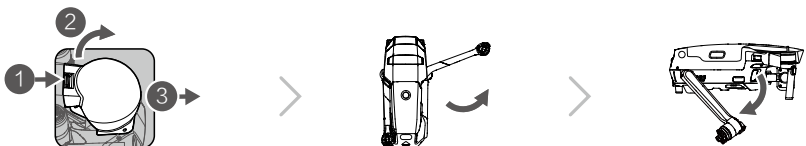

\* Attach the gimbal cover when not in use.

- 1) Hold the gimbal in place and insert the gimbal clamp between the aircraft and the gimbal.
- 2) Make sure the hooks on the gimbal protector are locked in the grooves of the aircraft. Lower the gimbal protector over the gimbal and secure with the buckle. The buckle will click when it is securely attached.

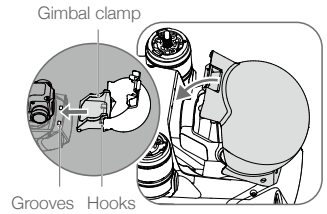

3. Attach the propellers with white marks to the motors with white marks. Press the propeller down onto the motors and turn until it is secure. Attach the unmarked propellers to the unmarked motors. Unfold all the propeller blades.

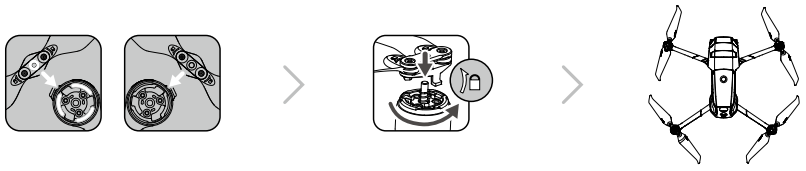

4. All Intelligent Flight Batteries are in Hibernation mode before shipping to ensure safety. Use the provided AC power adapter to charge and activate Intelligent Flight Batteries for the first time. To charge an Intelligent Flight Battery after flight, remove from the aircraft and attach to the AC power adapter.

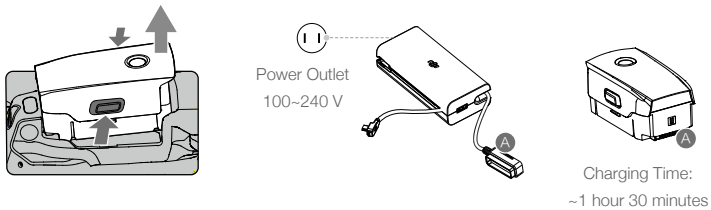

- 
- ⚠️ • Unfold the front arms and propellers before unfolding the rear arms.
  - It is normal for there to be friction on the arms and aircraft due to the folding design of Mavic 2 Enterprise Advanced.
  - Make sure the gimbal cover is removed and all arms and propellers are unfolded before powering on the aircraft. Otherwise, it may affect the aircraft's self-diagnostics.
-

## Preparing the Remote Controller

Two pairs of control sticks are included in the packaging for the Smart Controller. One pair is stored in the sticks storage slot on the back of the remote controller. Follow the steps below to attach the control sticks stored in the sticks storage slot to the remote controller.

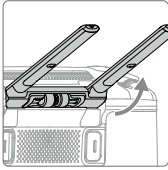

Lift the antennas

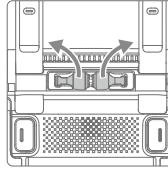

Remove the control sticks

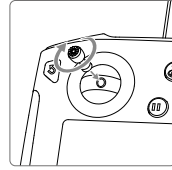

Rotate to attach the control sticks

Diagram

Mavic 2 Enterprise Advanced (L1TE)

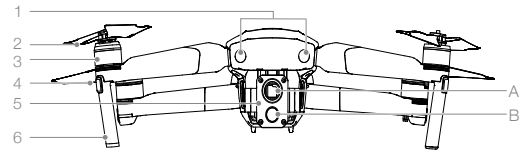

- 1. Forward Vision System
- 2. Propellers
- 3. Motors
- 4. Front LEDs
- 5. Gimbal and Camera
  - A. Thermal Camera
  - B. Visual Camera
- 6. Antennas

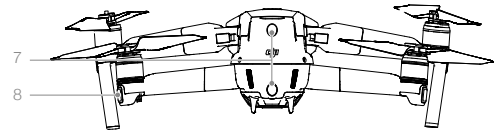

- 7. Backward Vision System
- 8. Aircraft Status Indicator

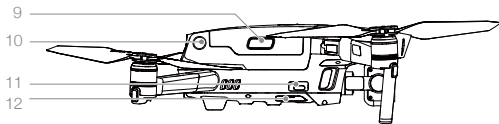

- 9. Battery Buckles
- 10. Lateral Vision System
- 11. USB-C Port
- 12. Link Button/Linking Status Indicator

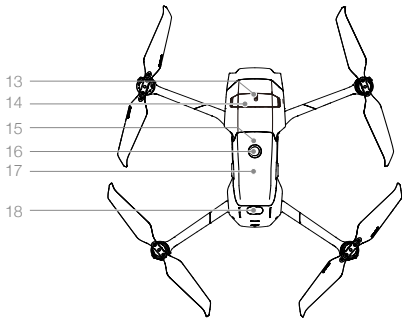

- 13. Extended Port (can be used to connect accessories)
- 14. Extended Port Cover
- 15. Battery Level LEDs
- 16. Power Button
- 17. Intelligent Flight Battery
- 18. Upward Infrared Sensing System

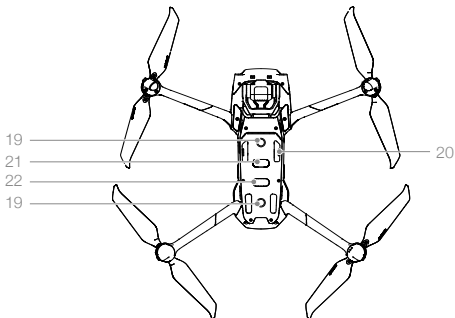

- 19. Downward Vision System
- 20. microSD Card Slot
- 21. Downward Infrared Sensing System
- 22. Auxiliary Bottom Light (can be used as a beacon in low light conditions)

DJI Smart Controller (RM500)

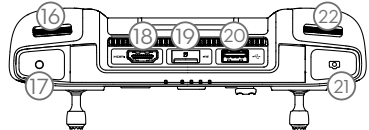
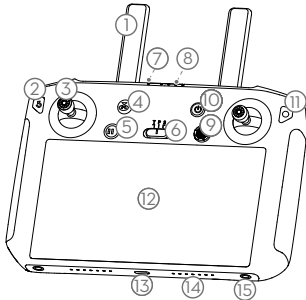

1. **Antennas**  
Relays aircraft control and video signal.
2. **Back Button/Function Button**  
Press once to return to the previous screen and press twice to go back to the home screen.
3. **Control Sticks**  
Control the orientation and movement of the aircraft when the remote controller is linked to an aircraft.
4. **Return to Home (RTH) Button**  
Press and hold the button to initiate RTH. The aircraft returns to the last recorded Home Point. Press again to cancel RTH.
5. **Flight Pause Button**  
Press to make the aircraft brake and hover in place (only when GPS or Vision System are available).
6. **Flight Mode Switch**  
Switch between T-mode, P-mode, and S-mode.
7. **Status LED**  
Indicates the linking status and warnings when the battery level is low, temperature is high, or the control sticks are not centered.
8. **Battery Level LEDs**  
Displays the battery level of the remote controller.
9. **5D Button**  
The default configuration is listed below. The configuration can be adjusted in DJI Pilot.  
**Up:** Recenter gimbal/move gimbal downward  
**Down:** Focus switch/metering  
**Left:** Decrease EV value  
**Right:** Increase EV value
10. **Power Button**  
Use to power the remote controller on or off. When the remote controller is powered on, press the button to enter sleep mode or to wake the controller.
11. **Confirm Button/Customizable Button C3**  
When the remote controller is not linked to an aircraft, press to confirm a selection. When linked to an aircraft, the button cannot be used to confirm a selection. The function of the button when linked to an aircraft can be customized in DJI Pilot.
12. **Touchscreen**  
Tap to select.
13. **USB-C Port**  
Use to charge or update the remote controller.
14. **Microphone**  
Records audio.
15. **Screw Holes**
16. **Gimbal Dial**  
Use to control the tilt of the camera.

**17. Record Button**

Press to start recording video. Press again to stop recording.

**18. HDMI Port**

For video output.

**19. microSD Card Slot**

Use to insert a microSD card.

**20. USB-A Port**

Use to connect external devices.

**21. Focus/Shutter Button**

Press once to take photos according to the mode selected in DJI Pilot.

**22. Camera Settings Dial/Gimbal Dial**

Turn to adjust the zoom of the camera.

**23. Air Vent**

Used for heat dissipation. DO NOT cover the air vent during use.

**24. Sticks Storage Slot**

Use to store a pair of control sticks.

**25. Customizable Button C2**

The default configuration is playback. The configuration can be set in DJI Pilot.

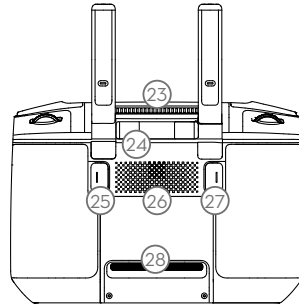

**26. Speaker**

Outputs sound.

**27. Customizable Button C1**

The default configuration is center focus. The configuration can be set in DJI Pilot.

**28. Air Intake**

Used for heat dissipation. DO NOT cover the air intake during use.



## Activation

### Activating the Smart Controller



The Smart Controller needs to be activated before using it for the first time. Make sure the remote controller is connected to the internet during activation. Follow the steps below to activate.

1. Power on the remote controller. Select the language and tap Next. Carefully read the terms of use and privacy policy and tap Agree. Set the country/region.
2. Connect the remote controller to the internet via Wi-Fi. After connecting, tap Next to continue and select the time zone, date, and time.
3. Log in with a DJI account. If you do not have an account, create a DJI account and log in.
4. Tap Activate on the activation page.
5. After activating, select whether to join the Smart Controller Improvement Project. The project helps to improve the user experience by automatically sending diagnostic and usage data daily. No personal data will be collected by DJI.
6. The remote controller will check for firmware updates. If a firmware update is available, a prompt will appear to download the latest version.

Check the internet connection if the activation fails. If the internet connection is normal, try to activate the remote controller again. If the issue persists, contact DJI.

### Activating the Aircraft

Mavic 2 Enterprise Advanced requires activation before using it for the first time. Follow the onscreen instructions to activate Mavic 2 Enterprise Advanced using DJI Pilot.

# Aircraft

---

This section introduces the flight controller, Intelligent Flight Battery, and the Forward, Backward, and Downward Vision Systems.

# Aircraft

Mavic 2 Enterprise Advanced contains a flight controller, vision systems, video downlink system, propulsion system, and an Intelligent Flight Battery. Refer to the aircraft diagram in the Product Profile section.

## Flight Modes

Mavic 2 Enterprise Advanced has three flight modes, plus a fourth flight mode that the aircraft switches to in certain circumstances:

**P-mode (Positioning):** P-mode works best when the GPS signal is strong. The aircraft utilizes GPS and the Vision Systems to locate itself, stabilize, and navigate between obstacles. When the Forward and Backward Vision Systems are enabled and lighting conditions are sufficient, the maximum flight altitude angle is 25°, the maximum forward flight speed is 31 mph (50 kph), and the maximum backward flight speed is 27 mph (43 kph). Note: P-mode requires larger stick movements to achieve high speeds. The aircraft automatically changes to Attitude (ATTI) mode when the Vision Systems are unavailable or disabled and when the GPS signal is weak or the compass experiences interference. When the Vision Systems are unavailable, the aircraft cannot position itself or brake automatically, which increases the risk of potential flight hazards. In ATTI mode, the aircraft may be more easily affected by its surroundings. Environmental factors such as wind can result in horizontal shifting, which may present hazards, especially when flying in confined spaces.

**S-mode (Sport):** In S-mode, Obstacle Sensing is disabled and the aircraft uses GPS and the Vision Systems for positioning. The maximum flight speed is 44.7 mph (72kph). The aircraft cannot sense or avoid obstacles. Note: In S-mode, aircraft responses are optimized for agility and speed making it more responsive to stick movements.

**T-mode (Tripod):** T-mode is based on P-mode and the flight speed is limited, which makes the aircraft more stable during shooting. The maximum flight, ascent, and descent speeds are limited to 1 m/s.



- Obstacle Sensing and the Upward Infrared Sensing System are disabled in S-mode, which means the aircraft cannot sense obstacles on its route automatically.
  - The maximum speed of the aircraft and braking distance significantly increase in S-mode. A minimum braking distance of 98.4 ft (30 m) is required in windless conditions.
  - Descent speed significantly increases in S-mode.
  - The responsiveness of the aircraft significantly increases in S-mode, which means a small stick movement on the remote controller translates into the aircraft moving a large distance. Pay attention and maintain adequate maneuvering space during flight.
  - Use the flight mode switch on the remote controller to switch between flight modes. To switch flight modes, first go to camera view in DJI Pilot, tap  and enable Multiple Flight Modes.
-

## Aircraft LEDs and Status Indicator

Mavic 2 Enterprise Advanced has Front LEDs and Aircraft Status Indicators as shown in the figure below.

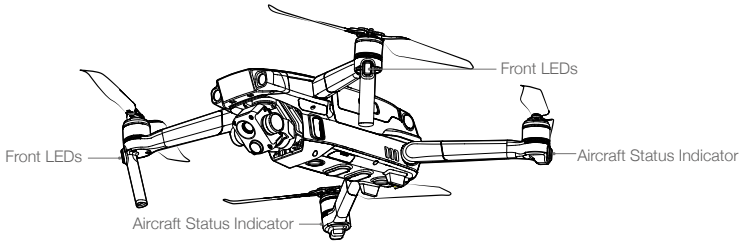

The Front LEDs show the orientation of the aircraft and glow solid red when the aircraft is powered on to indicate the front of the aircraft. Go to settings in DJI Pilot to turn the Front LEDs on or off.

The Aircraft Status Indicators communicate the status of the flight control system of the aircraft. Refer to the table below for more information about the Aircraft Status Indicators. The Aircraft Status Indicators also flash when the Home Point is being recorded as described in the Return to Home section.



### Aircraft Status Indicator States

Normal States		
	Blinks red, green, and yellow continuously	Powering on and performing self-diagnostic tests
	Blinks yellow and green alternately	Warming up
	Blinks green slowly	P-mode with GPS
	Blinks green twice continuously	P-mode with Forward and Downward Vision Systems
	Blinks yellow slowly	No GPS, Forward Vision System, or Downward Vision System
	Blinks green quickly	Braking
	Blinks green and blue alternately	RTK enabled and RTK data is being used
Warning States		
	Blinks yellow quickly	Remote controller signal lost
	Blinks red slowly	Low battery
	Blinks red quickly	Critically low battery
	Blinks red	IMU error
	Solid red	Critical error
	Blinks red and yellow alternately	Compass calibration required
	Blinks red and green alternately	RTK enabled but RTK data unavailable

For missions that require concealed flight, enter common settings in DJI Pilot and select LED Settings and turn the Frame Arm LEDs off.

## Return to Home

Return to Home (RTH) brings the aircraft back to the last recorded Home Point. There are three types of RTH: Smart RTH, Low Battery RTH, and Failsafe RTH. This section describes these three scenarios in detail.

☰	GPS	Description
Home Point		If a strong GPS signal was acquired before takeoff, the Home Point is the location from which the aircraft launched. The GPS signal strength is indicated by the GPS icon (  ). The Aircraft Status Indicator will blink green quickly when the Home Point is recorded.

### Smart RTH

If the GPS signal is sufficiently strong, Smart RTH can be used to bring the aircraft back to the Home Point. Smart RTH is initiated by pressing and holding the RTH button on the remote controller. Exit Smart RTH by pressing the RTH button on the remote controller.

### Low Battery RTH

Low Battery RTH is triggered when the Intelligent Flight Battery is depleted to the point that the safe return of the aircraft may be affected. Return home or land the aircraft immediately when prompted. DJI Pilot displays a warning prompt when the battery level is low. The aircraft will automatically return to the Home Point if no action is taken after a 10 second countdown.

The user can cancel RTH by pressing the RTH button or flight pause button on the remote controller. If RTH is cancelled following a low battery level warning, the Intelligent Flight Battery may not have enough power for the aircraft to land safely, which may lead to the aircraft crashing or being lost. The thresholds for the battery level warnings are automatically determined based on the current altitude of the aircraft and distance from the Home Point.

The aircraft will land automatically if the current battery level can only support the aircraft long enough to descend from its current altitude. The user cannot cancel the auto landing but can use the remote controller to alter the orientation of the aircraft during the landing process.

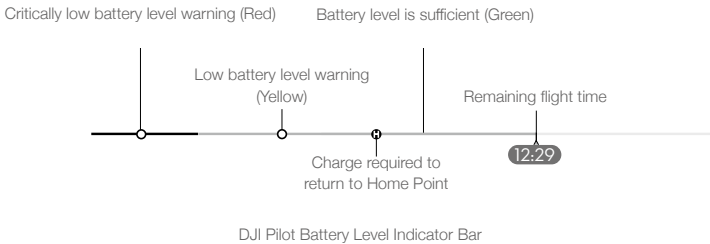

Warning	Scenario	Aircraft Status Indicator	DJI Pilot App	Actions
Low Battery Level	Remaining battery level supports RTH.	Blinks red slowly	Choose RTH or resume normal flight.	Select an option. If no action is taken, the aircraft will enter RTH.
	Remaining battery level supports Emergency RTH (when in RTH, with a normal remote controller signal, and at an altitude higher than 50 m).		Choose Emergency RTH or resume RTH.	Select an option. Emergency RTH (aircraft descends to 50 m and returns to the Home Point) or resume RTH (aircraft flies to Home Point without descending). If no action is taken, the aircraft will enter Emergency RTH.
	Remaining battery level supports Emergency Landing (when in RTH with a normal remote controller signal).		Aircraft lands. Action cannot be canceled.	Aircraft lands immediately.
Critically Low Battery Level	Aircraft lands after 10 seconds (when flying normally with a critical low battery level).	Blinks red quickly	Aircraft lands after 10 seconds. Action cannot be canceled.	Aircraft lands after 10 seconds.
	Aircraft lands automatically (when flying normally with an extremely critical low battery level).		Aircraft lands immediately. Action cannot be canceled.	Aircraft lands immediately.

## Failsafe RTH

The Forward Vision System allows the aircraft to create a real-time map of its flight route as it flies. If the Home Point was successfully recorded and the compass is functioning normally, Failsafe RTH automatically activates after the remote controller signal is lost for more than two seconds.

When Failsafe RTH is activated, the aircraft starts to retrace its original flight route home. If the remote control signal is re-established within 60 seconds of Failsafe RTH being activated, the aircraft hovers at its present location for 10 seconds and waits for pilot commands. Press the RTH button on the remote controller to cancel Failsafe RTH and retake control. If no pilot command is given, the aircraft flies to the Home Point in a straight line. If the remote control signal is still lost 60 seconds after activating Failsafe RTH, the aircraft stops retracing its original flight route and flies to the Home Point in a straight line.

## RTH Procedure

1. The aircraft adjusts its orientation.
2. a. If the aircraft is further than 20 m from the Home Point when RTH begins, it ascends to the pre-set RTH altitude and flies to the Home Point at a speed of 12 m/s. If the current altitude is higher than the RTH altitude, the aircraft flies to the Home Point at the current altitude. Forward and Backward Vision Systems are enabled.

- b. If the aircraft is between 5 and 20 m from the Home Point when RTH is initiated, the aircraft flies back at the current altitude. If the current altitude is less than 2 m, the aircraft will first ascend to 2 m and fly to the Home Point at a speed of 3 m/s. If RTH at Current Altitude is disabled, the aircraft lands immediately.
  - c. If the aircraft is less than 5 m from the Home Point when RTH is initiated, it lands immediately.
3. After reaching the Home Point, the aircraft lands and the motors stop.

### RTH Illustration

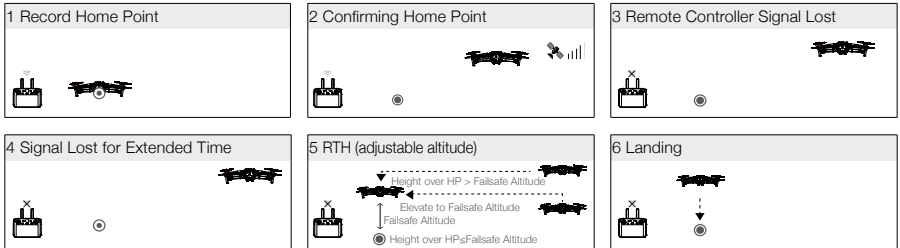

### Obstacle Avoidance During RTH

Provided that lighting conditions are sufficient for the Forward and Backward Vision Systems to operate, the aircraft senses and actively attempts to avoid obstacles during RTH. The obstacle avoidance procedure is as follows:

1. The aircraft decelerates when an obstacle is sensed.
2. The aircraft stops and hovers and then ascends until no obstacle is sensed.
3. The RTH procedure resumes and the aircraft flies to the Home Point at the new altitude.

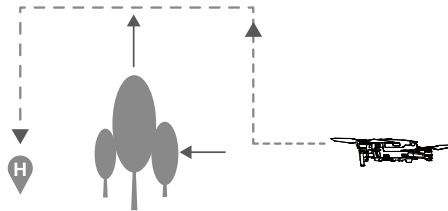

- The aircraft cannot return to the Home Point if the GPS signal is weak or unavailable.
- In Smart RTH and Low Battery RTH, the aircraft automatically ascends to an altitude of 65 ft (20 m). Once the altitude is 65 ft (20 m) or higher, move the throttle stick to make the aircraft stop ascending and fly to the Home Point at its current altitude.
- The aircraft cannot avoid obstacles during Failsafe RTH if the Forward and Backward Vision Systems are unavailable. It is important to set a suitable RTH Altitude before each flight. To set the RTH altitude, open DJI Pilot, and tap .
- During RTH, the orientation and direction of the aircraft cannot be controlled, but the remote controller or DJI Pilot can be used to control the speed and altitude.
- During RTH, obstacles on either side of the aircraft cannot be detected or avoided.

## Landing Protection

Landing Protection is activated during Smart RTH and the aircraft performs as follows:

1. When Landing Protection determines that the ground is suitable for landing, the aircraft lands gently.
2. If the ground is not suitable for landing, the aircraft hovers and waits for the pilot to confirm if it is suitable for landing or not.
3. If Landing Protection is not operational, DJI Pilot displays a landing prompt when the aircraft descends below 0.5 m. To land the aircraft, push the throttle stick down for one second or use the auto landing slider in DJI Pilot.

Landing Protection is active during Low Battery RTH and Failsafe RTH. The aircraft performs as follows:

During Low Battery RTH and Failsafe RTH, the aircraft hovers 2 m above the ground and waits for the pilot to confirm it is suitable to land. To land the aircraft, push the throttle stick down for one second or use the auto landing slider in the app. Landing Protection activates and the aircraft performs the steps listed above.



Vision Systems are disabled during landing. Make sure to land the aircraft with caution. Use caution when landing the aircraft.

---

## Precision Landing

Mavic 2 Enterprise Advanced automatically scans and attempts to match the terrain features underneath the aircraft during RTH. When the current terrain matches the Home Point terrain, the aircraft will start landing. A prompt will appear in DJI Pilot if the aircraft is unable to match the terrain.



- Landing protection is available during precision landing.
  - The performance of Precision Landing is subject to the following conditions:
    - a) The Home Point must be recorded upon takeoff and must not be changed during flight. Otherwise, the aircraft will have no record of the terrain features of the Home Point.
    - b) During takeoff, the aircraft must ascend at least 7 m before moving horizontally.
    - c) The Home Point terrain features must remain largely unchanged.
    - d) The Home Point terrain features must be distinguishable.
    - e) The lighting conditions must not be too light or too dark.
  - The following actions are available during Precision Landing:
    - a) Press the throttle stick down to accelerate landing.
    - b) Move the control sticks in any other direction to stop Precision Landing. The aircraft will descend vertically after the control sticks are released.
- 

## Vision Systems and Infrared Sensing Systems

Mavic 2 Enterprise Advanced is equipped with Forward, Backward, Downward, and Lateral Vision Systems, and Upward and Downward Infrared Sensing Systems. They provide the aircraft with omnidirectional obstacle sensing if lighting conditions are adequate.

The main components of the Forward, Backward, and Downward Vision Systems are six cameras located on the front, back, and bottom of the aircraft. The Lateral Vision Systems are two cameras located on either side of the aircraft. The main components of the Upward and Downward Infrared Sensing Systems are two 3D infrared modules located on the top and bottom of the aircraft.

The Downward Vision System and Infrared Sensing System helps the aircraft maintain its current position and hover in place more precisely and to fly indoors or in other environments where a GPS



signal is unavailable. In addition, the auxiliary bottom light located on the bottom of the aircraft improves visibility for the Downward Vision System in weak light conditions.

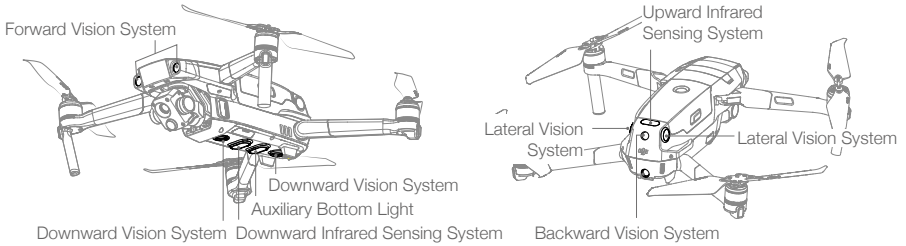

### Detection Range

The detection range of the Vision Systems is depicted as followed. Note that the aircraft cannot sense or avoid the obstacles that are not within detection range.

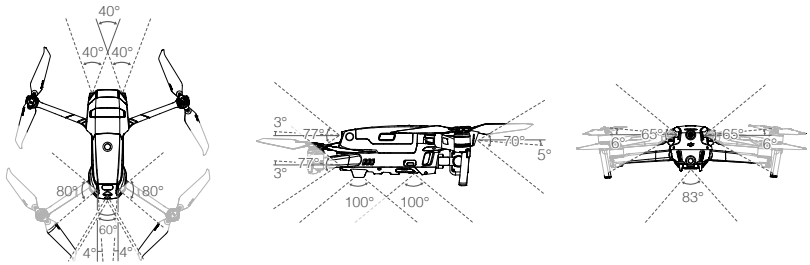

### Calibrating Vision System Cameras

The Vision Systems installed on the aircraft are factory calibrated. If a collision occurs, the aircraft may need to be calibrated via DJI Pilot or DJI Assistant 2 (Enterprise Series) for Mavic.

The most accurate way to calibrate the Vision System cameras is by using DJI Assistant 2 (Enterprise Series) for Mavic. Follow the steps below to calibrate the Forward Vision System cameras and repeat the steps to calibrate other Vision System cameras.

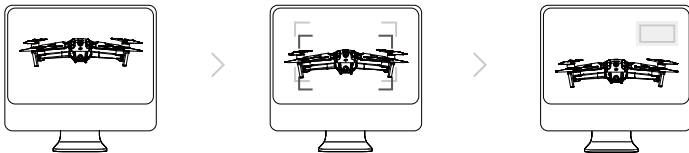

01  
Point the aircraft toward the screen

02  
Align the boxes

03  
Pan and tilt the aircraft

## Using the Vision Systems

The Downward Vision System and Infrared Sensing System activate automatically when the aircraft is powered on. No further action is required. When using the Downward Vision System, the aircraft can hover precisely even without GPS.

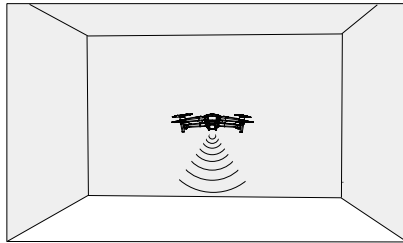

The Downward Vision System is typically used in indoor environments where GPS is unavailable. The Downward Vision System works best when the aircraft is at an altitude of 1.6 to 33 ft (0.5 to 11 m). Note that Vision Positioning may be affected if the altitude of the aircraft is above 33 ft (11 m).

### Follow the steps below to use the Downward Vision System:

1. Make sure the aircraft is in P-mode and place the aircraft on a flat surface.  
Note that the Downward Vision System cannot work properly on surfaces without clear pattern variations.



2. Power on the aircraft. The aircraft hovers in place after takeoff. The Aircraft Status Indicators flash green twice, which indicates the Downward Vision System is working.

Using the Forward and Backward Vision Systems, the aircraft can actively brake when detecting obstacles in front. The Forward and Backward Vision Systems work best with adequate lighting and clearly marked or textured obstacles. To allow for sufficient braking time, avoid flying the aircraft more than 31 mph (50 kph) when flying forward or more than 27 mph (42 kph) when flying backward.

The Lateral Vision Systems requires better lighting and more textured or clearly marked obstacles, and cannot sense dynamic objects such as moving people, vehicles, tree branches, or blinking lights.

The Lateral Vision Systems are only available in Tripod Mode. The angular speed is limited to 24° /s and the lateral flight speed is limited to 18 mph (29 km/h).



- The Lateral Vision Systems have limited ability to sense and avoid obstacles, and their performance may be affected by the surrounding environment. Make sure to maintain line of sight with the aircraft and pay attention to prompts in DJI Pilot. DJI takes no responsibility for any aircraft that is damaged or lost while using the Lateral Vision Systems.
- The Downward Vision System cannot work properly over surfaces that DO NOT have clear pattern variations. The Downward Vision System is only effective when the aircraft is at an altitude of 0.5 to 50 meters. Note that Vision Positioning may be affected if the altitude of the aircraft is above 33 ft (11 m).
- The auxiliary bottom light is automatically enabled in low-light environments when the aircraft is operating at an altitude under 5 m. Note that the Vision Systems cameras performance may be affected when the auxiliary bottom light is enabled. Fly with caution if the GPS signal is weak.
- The Downward Vision System may not function properly when the aircraft is flying over water or snow-covered areas.



- Note that the Vision Systems may not function properly when the aircraft is flying too fast. Fly with caution when flying at over 10 m/s (32.8 ft/s) at 2 m (6.6 ft) or over 5 m/s (16.4 ft) at 1 m (3.3 ft).
- Operate the aircraft cautiously when in any of the following situations:
  - a) Flying over monochrome surfaces (e.g., pure black, pure white, pure green).
  - b) Flying over highly reflective surfaces.
  - c) Flying over water or transparent surfaces.
  - d) Flying over moving surfaces or objects.
  - e) Flying in an area where the lighting changes frequently or drastically.
  - f) Flying over extremely dark (< 10 lux) or bright (> 40,000 lux) surfaces.
  - g) Flying over surfaces that strongly reflect or absorb infrared waves (e.g., mirrors).
  - h) Flying over surfaces without clear patterns or texture.
  - i) Flying over surfaces with repeating identical patterns or textures (e.g., tiles with the same design).
  - j) Flying over obstacles with small surface areas (e.g., tree branches).
- Keep the sensors clean at all times. DO NOT tamper with the sensors. Do not obstruct the Infrared Sensing System.
- The Forward and Backward Vision Systems may not be able to recognize patterns on the ground in low light conditions (less than 100 lux). If the aircraft speed exceeds 31 mph (50 kph), the Forward and Backward Vision Systems do not have enough time to brake and stop the aircraft at a safe distance from an obstacle.
- If the aircraft is involved in a collision, it may be necessary to calibrate the Vision Systems. Calibrate the Vision Systems if the app prompts you to do so.
- Do not fly if it is rainy, foggy, or if there is no clear sight.
- Check the following each time before takeoff:
  - a) Make sure there are no stickers or any other obstructions over the glass of the Infrared Sensing and Vision Systems.
  - b) Use a soft cloth if there is any dirt, dust, or water on the glass of the Infrared Sensing and Vision Systems. Do not use any cleaning products that contains alcohol.
  - c) Contact DJI Support if there is any damage to the glass of the Infrared Sensing and Vision Systems.
- The Upward Infrared Sensing System only detects in a straight line directly above the sensor and not the entire area above the aircraft. Additionally, large obstacles such as roofs can be detected, but tiny obstacles such as leaves or electrical wires cannot. Fly with caution and do not rely solely on the Upward Infrared Sensing System to detect obstacles above the aircraft.
- Do not obstruct the Downward Vision System or Downward Infrared Sensing System before takeoff. Otherwise, the aircraft cannot take off again after landing and will have to be restarted.

## Flight Recorder

Flight data including flight telemetry, aircraft status information, and other parameters are automatically saved to the internal data recorder of the aircraft. The data can be accessed using DJI Assistant 2 (Enterprise Series).

## Password Protection



Mavic 2 Enterprise Advanced supports password protection. This feature helps ensure secure access to the aircraft and its onboard data storage, which helps prevent the leaking of sensitive information.

To set, change, or delete the password, launch the DJI Pilot app, select Settings, and then Security Password.

- ⚠ The password is stored in the aircraft only and will not be uploaded to the DJI server. Therefore, the aircraft needs to be reformatted if the password is lost. The data stored in the aircraft will be deleted once the aircraft is formatted.
- If the aircraft requires maintenance, DJI will reformat the onboard data of the aircraft. Remove the security password and back up data before sending the aircraft back for repair. DJI takes no responsibility for any loss of data.

## Attaching and Detaching the Propellers

Mavic 2 Enterprise Advanced uses low-noise propellers. There are two types of propellers, which are designed to spin in different directions. White marks are used to indicate which propellers should be attached to which motors.

Marked	Unmarked
	
Attach on motors with white marks	Attach on motors without white marks

🔧 Turn the propellers in the indicated direction to mount and tighten.

### Attaching the Propellers

Attach the propellers with the white marks to the motors with white marks and the unmarked propellers to the motors without marks. Hold the motor, press the propeller down, and rotate in the direction marked on the propeller until it pops up and locks in place.

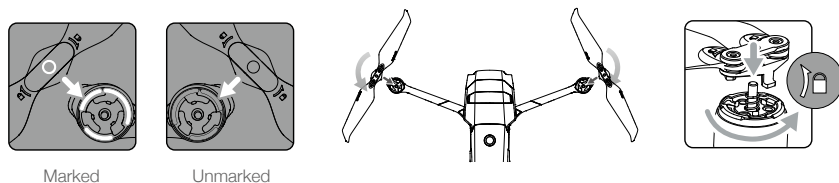

### Detaching the Propellers

Hold the motor, press the propeller down, and rotate in the opposite direction to the one marked on the propeller until it pops out.

- ⚠ The propeller blades are sharp. Handle with care.
- Only use original DJI propellers. Do not mix propeller types.
- Purchase the propellers separately if necessary.
- Make sure that the propellers and motors are installed securely before each flight.
- Make sure that all propellers are in good condition before each flight. Do not use aged, chipped, or broken propellers.
- To avoid injury, stand clear of and do not touch propellers or motors when they are spinning.
- To avoid damaging the propellers, place the aircraft in the direction shown in the carrying case during transportation or storage. Do not squeeze or bend the propellers. If propellers are damaged, the flight performance is affected.

- ⚠ • Make sure the motors are mounted securely and rotating smoothly. Land the aircraft immediately if a motor is stuck and unable to rotate freely.
- DO NOT attempt to modify the structure of the motors.
- DO NOT touch or let hands or body parts come in contact with the motors after flight as they may be hot.
- DO NOT block any of the ventilation holes on the motors or the body of the aircraft.
- Make sure the ESCs sound normal when powered on.

## Intelligent Flight Battery

The Mavic 2 Enterprise Advanced Intelligent Flight Battery is a 15.4 V, 3850 mAh battery with smart charging and discharging functionality. Only use a DJI approved AC power adapter to charge the battery.

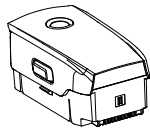

Intelligent Flight Battery



AC Power Adapter

### Battery Features

1. **Battery Level Display:** the battery level LEDs display the current battery level.
2. **Auto-Discharging Function:** to prevent swelling, the battery automatically discharges to less than 60% of the maximum battery level when it is idle for more than 10 days. It takes approximately three to four days to discharge the battery to 65%. It is normal to feel moderate heat being emitted from the battery during the discharge process.
3. **Balanced Charging:** the voltages of the battery cells are automatically balanced during charging.
4. **Overcharge Protection:** the battery stops charging automatically once fully charged.
5. **Temperature Detection:** the battery only charges when the temperature is between 41° and 104° F (5° and 40° C).
6. **Overcurrent Protection:** the battery stops charging if an excess current is detected.
7. **Over-discharge Protection:** discharging stops automatically to prevent over-discharge.
8. **Short Circuit Protection:** the power supply is automatically cut if a short circuit is detected.
9. **Battery Cell Damage Protection:** a warning prompt will appear in DJI Pilot when a damaged battery cell is detected.
10. **Hibernation Mode:** the battery switches off after 20 minutes of inactivity to save power. If the battery level is less than 10%, the battery enters Hibernation mode to prevent over-discharging. In Hibernation mode, the battery level indicators do not illuminate. Charge the battery to wake it from hibernation.
11. **Communication:** information about the voltage, capacity, and current of the battery is transmitted to the aircraft.
12. **Heating:** the batteries of the Mavic 2 Enterprise Advanced are self-heating, enabling them to work in harsh and cold weather conditions as low as -4° F (-20° C).

 Refer to the Mavic 2 Intelligent Flight Battery Safety Guidelines before use. Users take full responsibility for all operations and usage.

## Using the Battery

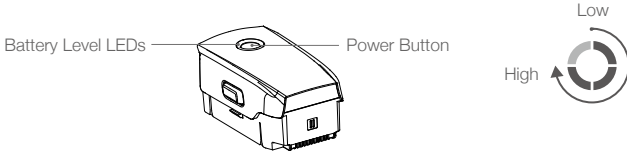

### Checking Battery Level

The battery level LEDs display how much charge is remaining. If the battery is powered off, press the power button to make the battery level LEDs light up to display the current battery level.

### Powering On/Off

Press the power button once and press and hold for two seconds to power the battery on or off.

### Heating the Battery

**Manual Heating:** make sure the battery is powered off. Press and hold the power button for five seconds to warm up the battery manually.

As the battery warms up, the brightness of the battery level LEDs will change from no light, low light, medium light, to high light. The battery will stop warming up when it reaches 46° F (8° C) and the battery level LEDs will blink clockwise, indicating that the battery temperature is between 46° to 50° F (8° to 10° C). This will last for approximately 20 minutes before the battery automatically powers off.

**Auto Heating:** insert the battery into the aircraft and power it on. When the temperature of the battery is below 43° F (6° C) and the battery level is above 45%, it will warm up automatically and the temperature will remain between 46° to 50° F (8° to 10° C).

### Low Temperature Notice

1. Battery capacity is significantly reduced when flying in low-temperature environments of -4° to 41° F (-20° to 5° C). It is recommended to heat the battery before use and make sure to fully charge the battery before takeoff.
2. Batteries cannot be used in extremely low-temperature environments of less than -4° F (-20° C).
3. To ensure the optimal performance of the battery, warm up the battery so the temperature is above 46° F (8° C) before use.
4. Reduced battery capacity in low-temperature environments reduces the wind speed resistance of the aircraft. Fly with caution.
5. Fly with extra caution at a high sea level.
6. The heating function cannot be initiated when the battery temperature is higher than 43° F (6° C) or the battery level is lower than 45%.
7. When the temperature is below -4° F (-20° C), low temperature protection will be triggered and the battery will not power on. The aircraft exits low temperature protection when the battery temperature reaches 5° F (-15° C).

## Charging the Battery

Fully charge the Intelligent Flight Battery before using for the first time:

1. Connect the AC power adapter to a power source (100-240 V, 50/60 Hz).
2. Attach the Intelligent Flight Battery to the AC power adapter using the battery charging cable with the battery powered off.
3. The battery level LEDs display the current battery level during charging.
4. The Intelligent Flight Battery is fully charged when the battery level LEDs are all powered off.  
Detach the AC power adapter when the battery is fully charged. It takes 1 hour and 30 minutes to fully charge.

- ⚠️ • DO NOT charge an Intelligent Flight Battery immediately after flight as the temperature may be too high. Wait until it cools down to room temperature before charging again.
- The AC power adapter stops charging the battery if the battery cell temperature is not within the operating range of 41° to 104° F (5° to 40° C). The ideal charging temperature is 71.6° to 82.4° F (22° to 28° C).
  - The Battery Charging Hub (not included) can charge up to four batteries. Visit the official DJI online store for more information.

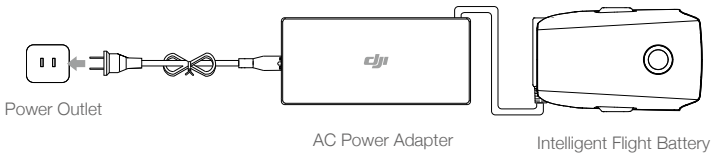

## Battery Level LEDs During Charging

	LED1	LED2	LED3	LED4
Battery Level LEDs During Charging				
Battery Level	0%~25%	25%~50%	50%~75%	75%~100%

## Battery Protection

Battery Protection Mechanisms					
LED1	LED2	LED3	LED4	Blinking Pattern	Battery Protection Description
				LED 2 blinks twice per second	Overcurrent detected
				LED 2 blinks three times per second	Short circuit detected
				LED 3 blinks twice per second	Overcharge detected
				LED 3 blinks three times per second	Charger overvoltage detected
				LED 4 blinks twice per second	Charging temperature is too low
				LED 4 blinks three times per second	Charging temperature is too high

### Inserting the Intelligent Flight Battery

Insert the Intelligent Flight Battery into the battery compartment of the aircraft. Make sure it is mounted securely and that the battery latches have clicked into place.

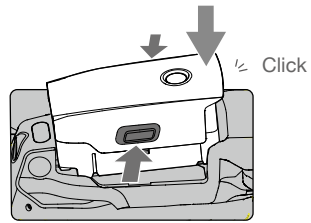

### Removing the Intelligent Flight Battery

Slide the battery latches on the sides of the Intelligent Flight Battery to open the battery compartment.

- ⚠ • DO NOT insert or remove the battery while it is powered on.
- Make sure the battery is mounted securely.

## Gimbal and Camera

### Gimbal

The Mavic 2 Enterprise Advanced 3-axis gimbal provides stabilization for the camera, enabling users to capture clear and stable images and video. The gimbal has a tilt range of  $-90^{\circ}$  to  $+30^{\circ}$ . Users can also go to gimbal settings to set the gimbal mode and enable auto calibration.

Use the gimbal dial on the remote controller to control the tilt of the camera. Alternatively, enter the live view in DJI Pilot. Double tap to center or press the screen until a blue circle appears and drag the circle up and down to control the tilt of the camera and left and right to control the orientation of the aircraft.

### Gimbal Operation Modes

Two gimbal operation modes are available, which can be set under camera settings on DJI Pilot.

**Follow Mode:** the angle between the orientation of the gimbal and the aircraft front remains constant at all times.

**FPV Mode:** the gimbal synchronizes with the movement of the aircraft to provide a first-person flying experience.

- ⚠ • Do not tap or knock the gimbal when the aircraft is powered on. Take off from open and flat ground to protect the gimbal during takeoff.
- Precision elements in the gimbal may be damaged by a collision or impact, which may cause the gimbal to function abnormally.
- Avoid getting dust or sand on the gimbal, especially in the gimbal motors.
- A gimbal motor error may occur if the aircraft is on uneven ground, the gimbal is obstructed, or the gimbal experiences a collision or crash.
- DO NOT apply external force to the gimbal after the gimbal is powered on. DO NOT add any extra payload to the gimbal as this may cause the gimbal to function abnormally or even lead to permanent motor damage.
- Make sure to remove the gimbal cover before powering on the aircraft. Also, make sure to mount the gimbal cover when the aircraft is not in use.
- Flying in heavy fog or clouds may make the gimbal wet, leading to temporary failure. Allow the gimbal to dry to recover full functionality.



## Camera

Mavic 2 Enterprise Advanced features a thermal camera and a visual camera, providing both infrared and visible light imaging simultaneously. The visual camera uses a 1/2" CMOS sensor and supports up to 32x digital zoom with focus range of 1 m to infinity.

Mavic 2 Enterprise Advanced shoots up to 4K 30fps video and 48MP photos. Shooting modes include Single Shot, Interval, and Panorama.

- 
- ⚠ • Make sure the temperature and humidity are suitable for the camera during use and storage.
  - Use a lens cleanser to clean the lens to avoid damage.
  - DO NOT block any ventilation holes on the camera as the heat generated may damage the device and injure the user.
- 

## Storing Photos and Videos

Mavic 2 Enterprise Advanced comes with 24 GB of internal storage for storing photos and videos. Enable password protection to protect data and ensure secure access to the device.

A microSD card can also be used to store photos and videos. A UHS-I Speed Grade 3 rating microSD card is required due to the fast read and write speeds necessary for high-resolution video data.

To view the date and time photos and videos are taken, open the app and enable Add Timestamp and GPS Info under camera settings.

- 
- ⚠ • Do not remove the microSD card from the aircraft when it is powered on. Otherwise, the microSD card may be damaged.
  - To ensure the stability of the camera system, single video recordings are limited to 30 minutes.
  - Check camera settings before use to ensure they are configured correctly.
  - Before shooting important photos or videos, shoot a few images to test whether the camera is operating correctly.
  - Photos and videos cannot be transmitted or copied from the camera if the Intelligent Flight Battery is powered off.
  - Make sure to power off the Intelligent Flight Battery correctly. Otherwise, your camera parameters will NOT be saved and any recorded videos may be damaged. Note that regardless of the reason, DJI is not responsible for any failure of an image or video to be recorded or having been recorded in a way that is not machine-readable.
- 

Three files will be saved when using Split display mode.

Display Mode	Photo	Video
Thermal	Visible + IR	Visible + IR
Visible	Visible + IR	Visible + IR
Split	Visible + IR + Split	Visible + IR

## Video Edit

Mavic 2 Enterprise Advanced supports MP4 video format, as well as H.264 coding format and capturing of visible light and thermal imaging.

## DJI AirSense

Manned aircraft with an ADS-B transceiver actively broadcast flight information, including their location, flight path, speed, and altitude. DJI AirSense receives this information from ADS-B transceivers via an on-board receiver or internet connection. UAVs with DJI AirSense installed can obtain the position, orientation, and velocity information from the built-in ADS-B transmitter (1090ES or UAT) of a manned aircraft, calculate the collision risk level in real time, and send the warning to the user. DJI AirSense then analyzes the potential collision risk by comparing the location of the manned aircraft and sends timely warning prompts to the user via DJI Pilot.

DJI AirSense provides information about nearby manned aircraft to ensure flight safety. It does not actively control the drone to avoid incoming aircraft. Always fly your aircraft within a visual line of sight and be cautious at all times. Lower your altitude when you receive warning prompts. Be aware that DJI AirSense has the following limitations:

1. It can only receive messages sent by manned aircraft with an ADS-B out device installed in accordance with 1090ES (RTCA DO-260) or UAT (RTCA DO-282). DJI devices cannot receive related broadcast messages or warning prompts from manned aircraft that are not equipped with functioning ADS-B out devices.
2. If there is an obstacle or steel structure between a manned aircraft and DJI aircraft, DJI AirSense will not be able to receive ADS-B messages sent by the manned aircraft or send warning prompts to the user. Pay close attention to your surroundings and fly with caution.
3. Warning prompts may be delayed if DJI AirSense experiences any interference from the surrounding environment. Closely observe the surrounding environment and fly with caution.
4. Warning prompts may not be received if the DJI aircraft is unable to determine its location.
5. If disabled or misconfigured, DJI AirSense cannot receive ADS-B messages sent by manned aircraft or send warning prompts to the user.

When DJI AirSense detects the possibility of a collision, it sends a series of warning prompts based on the distance between the manned aircraft and the DJI aircraft (when the connection between the DJI aircraft and the remote controller is stable). After receiving the first warning prompt it is recommended to immediately descend or choose another flight path to avoid a collision.

### Warning Escalation:

1. The lowest level warning occurs when a manned aircraft is detected. Up to 10 detected aircraft can be displayed in DJI Pilot at a time. Pay attention to ensure flight safety.
2. The medium level warning occurs when the DJI aircraft is two km away from a manned aircraft. Pay attention to avoid any safety hazards.
3. The highest level warning occurs when the DJI aircraft is one km away from a manned aircraft. Descend or change the flight path immediately to avoid the manned aircraft.



Blue: The first level warning



Yellow: The second level warning



Red: The third level warning

## Modular Accessories

Mavic 2 Enterprise Advanced features an extended port for mounting additional compatible DJI modular accessories that are listed below:

M2E Beacon: helps to identify aircraft during flight at night or in low light areas.

M2E Spotlight: used for long-range illumination to search in low-light conditions and assist when shooting with the camera at night.

M2E Speaker: used for long-range, real-time broadcasting or audio playback.

M2EA RTK Module: supports NTRIP and is capable of centimeter-level positioning accuracy.



M2E Beacon

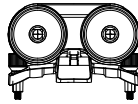

M2E Spotlight



M2E Speaker

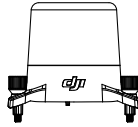

M2EA RTK Module  
(not included)

## Usage

The following example illustrates how to install and use the modular accessories. The M2E Beacon is used as an example.

1. Remove the extended port cover on top of the aircraft. Make sure it is stored in a safe place for future use.
2. Mount the beacon onto the extended port of the aircraft.
3. Tighten the knobs on both sides to ensure that the beacon is firmly mounted onto the aircraft.

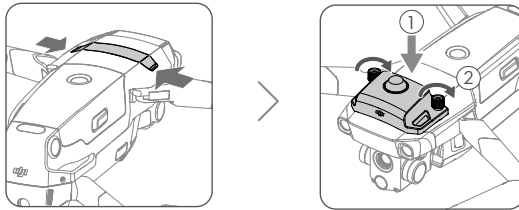

4. Power on the aircraft and launch DJI Pilot to use the beacon.



- The auxiliary bottom light can be used as a beacon. Go to Visual Navigation Settings in the app and set the Bottom Auxiliary Light to Night Light.

- ⚠ • Make sure that the accessories are correctly and securely mounted on the aircraft before use. Otherwise, they may fall from the aircraft during flight.
  - DO NOT point the spotlight or the beacon directly at people's eyes.
  - DO NOT use the speaker near people or in an urban area where noise-sensitive structures are concentrated as the loudness could lead to accidents or injuries.
- 

## Using the RTK Module

### Enable/Disable RTK

Make sure that RTK positioning is enabled and the RTK service type is correctly set to either Network RTK or Custom Network RTK before each use. Go to Camera View > ●●● > RTK to set the service type. Otherwise, the aircraft will be unable to take off when there is no differential data.

### Using with Custom Network RTK

Connect a dongle to the remote controller or use the app to connect to Wi-Fi and to use the Custom Network RTK. Custom Network RTK can be used in place of a RTK base station. Connect the Custom Network RTK account to the designated NTRIP server to send and receive differential data. Keep the remote controller powered on and connected to the internet while using this function.

1. Make sure the remote controller and the aircraft are linked and the app is connected to the internet.
2. Go to Camera View > ●●● > RTK to set the RTK service type as Custom Network RTK and fill in the NTRIP host, port, account, password, and mount point information.
3. Wait to connect to the NTRIP server. In RTK Settings, the positioning of the aircraft is displayed as FIX to indicate that the aircraft has obtained and used the differential data from the Custom Network RTK.

# Smart Controller

---

This section describes the features of the remote controller and includes instructions for controlling the aircraft and the camera.

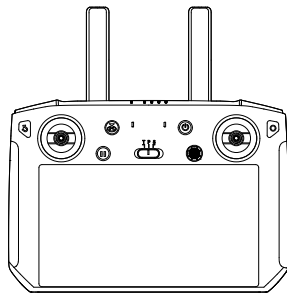

# Smart Controller

## Smart Controller Profile

The DJI Smart Controller uses DJI's OcuSync 2.0 long-range transmission technology, offering a maximum transmission range of 6.2 mi (10 km) and displaying video from the aircraft to DJI Pilot on a mobile device at up to 720p resolution. The onboard buttons make controlling the aircraft easy and its detachable control sticks make it convenient to store.

In wide-open areas with no electromagnetic interference, OcuSync 2.0 smoothly transmits video links at up to 720p regardless of the flight attitude. The remote controller transmission works at both 2.4 GHz and 5.8 GHz, automatically selecting the best transmission channel.

OcuSync 2.0 also reduces latency to 120-130 ms by improving the camera performance through the video decoding algorithm and the wireless link.

The Smart Controller has a built-in 5.5-inch high-brightness screen with multiple functions such as Bluetooth connectivity and GNSS satellite positioning. The remote controller can also connect to the internet via Wi-Fi and has a maximum working time of 2.5 hours.

## Smart Controller Operations

### Powering the Smart Controller On and Off

Follow the steps below to power the remote controller on and off.

1. Press the power button once to check the current battery level. Charge the remote controller if the battery level is too low.
2. Hold the power button or press and hold the power button to power on the remote controller.
3. Repeat Step 2 to power off the remote controller.

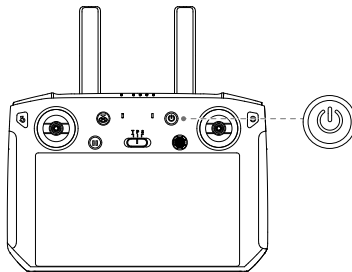

## Charging the Battery

There are two pairs of built-in 18650 Li-ion batteries in the remote controller. Charge the remote controller using the USB-C port.

Charging Time: approx. 2 hours and 15 minutes. (using a standard USB charger adapter )

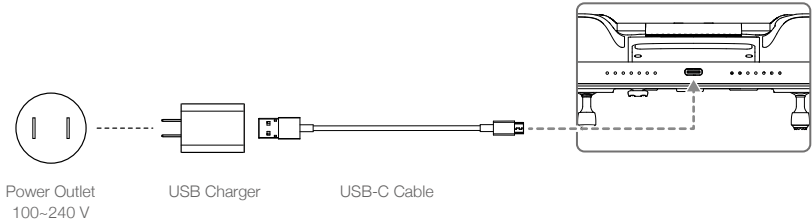

- ⚠ • Use a DJI official USB power adapter to charge the remote controller. If a DJI official adaptor is unavailable, using a certified FCC/CE rated 12V/2A USB adapter is recommended.
- The battery will deplete when stored for an extended period. Recharge the battery at least once every three months to prevent over discharge.

## Operating the Camera

Shoot photos and videos with the focus/shutter button and record button on the remote controller.

1. Record Button  
Press once to start recording video and press again to stop.
2. Focus/Shutter Button  
Press to take a photo.
3. Camera Settings Dial  
Turn to adjust the zoom of the camera.

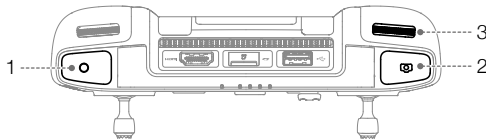

## Controlling the Aircraft

The control sticks control the aircraft's orientation (yaw), forward and backward movement (pitch), altitude (throttle), and left and right movement (roll). The control stick mode determines the function of each control stick. There are three pre-programmed modes as well as custom modes that can be configured in DJI Pilot. The modes are Mode 1, Mode 2, and Mode 3. The default mode is Mode 2. In each of the three pre-programmed modes, the aircraft hovers in place at a constant orientation when both sticks are centered. See the figures below to check the function of each control stick in the three pre-programmed modes.

Mode 1

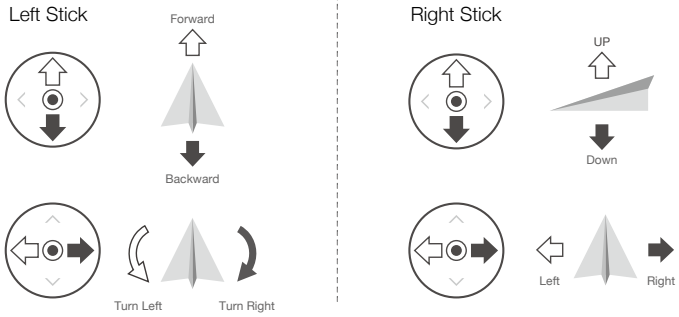

Mode 2

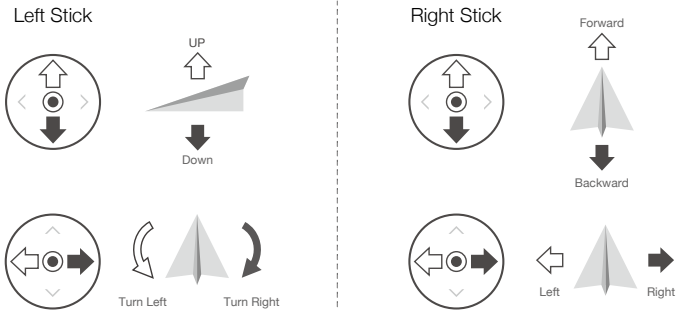

Mode 3

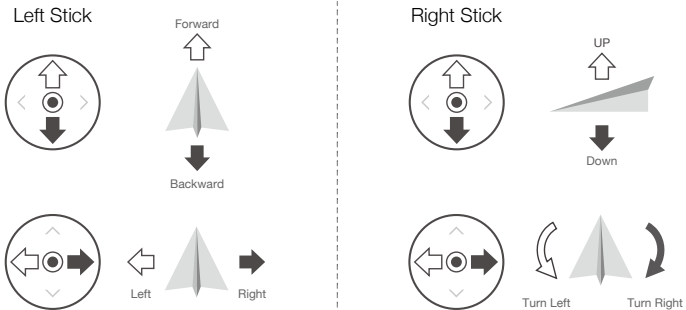







The figure below explains how to use each control stick. Mode 2 is used as an example.

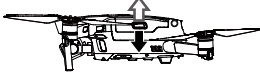

Center position: control sticks are centered.

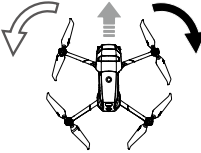
Moving the control stick: control sticks are pushed away from the center.



Remote Controller (Mode 2)	Aircraft ( ◀ Indicates Nose Direction)	Remarks
		<p>Moving the left stick up or down changes the altitude of the aircraft.</p> <p>Push the stick up to ascend and down to descend.</p> <p>The more the stick is pushed away from the center, the faster the aircraft changes altitude. Push the stick gently to prevent sudden and unexpected changes in altitude.</p>
		<p>Moving the left stick to the left or right controls the orientation of the aircraft.</p> <p>Push the stick left to rotate the aircraft counter-clockwise and right to rotate the aircraft clockwise.</p> <p>The more the stick is pushed away from the center, the faster the aircraft rotates.</p>
		<p>Move the right stick up and down to change the pitch of the aircraft.</p> <p>Push the stick up to fly forward and down to fly backward. The more the stick is pushed away from the center, the faster the aircraft moves.</p>
		<p>Moving the right stick to the left or right changes the roll of the aircraft.</p> <p>Push the stick left to fly left and right to fly right. The more the stick is pushed away from the center, the faster the aircraft moves.</p>

- ⚠ • Keep the remote controller away from magnetic materials to avoid it being affected by magnetic interference.
- To avoid damage, it is recommended that the control sticks are removed and stored in the storage slot on the remote controller during transportation or storage.

### Flight Mode Switch

Toggle the switch to select the flight mode. Choose between T-mode, P-mode, and S-mode.

Position	Flight Mode
T	T-mode (Tripod)
P	P-mode (Positioning)
S	S-mode (Sport)

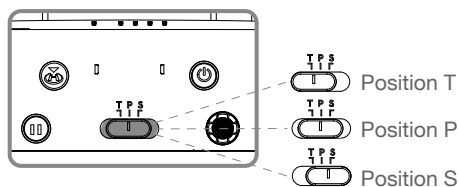

Mavic 2 Enterprise Advanced begins in P-mode by default regardless of the position the switch is in on the remote controller. To switch flight modes, first go to Camera View in DJI Pilot, tap and enable Multiple Flight Modes. After enabling multiple flight modes, toggle the switch to P and then to S or T to switch flight modes.

### RTH Button

Press and hold the RTH button to initiate RTH and the aircraft will return to the last recorded Home Point. Press the button again to cancel RTH and regain control of the aircraft. Refer to the Return to Home section for more information about RTH.

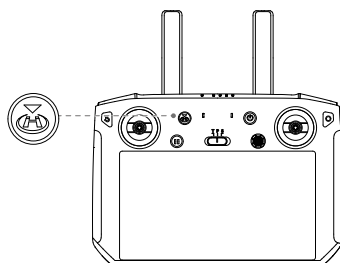

### Customizable Buttons

There are three customizable buttons on the controller: C1, C2, and the Confirm button. When the remote controller is not linked to an aircraft, press the Confirm button to confirm a selection. When the remote controller is linked to an aircraft, the button cannot be used to confirm a selection. However, the function of the button when linked to an aircraft can be customized in DJI Pilot.

The functions of the C1 and C2 buttons are set in DJI Pilot. The default configuration for the C1 button is center focus and the default configuration for the C2 button is playback.

## Optimal Transmission Zone

The optimal transmission range of the Smart Controller is shown below:

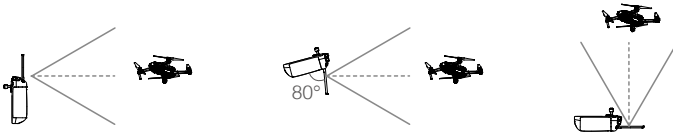

Make sure the antennas are facing towards the aircraft. The signal between the remote controller and the aircraft can reach its optimal performance when the angle between the antennas and the back of the Smart Controller is 80° or 180°.

Note that the illustrations above do not reflect the actual distances between the user and aircraft and are for reference only.

-  A warning prompt appears in DJI Pilot if the transmission signal is weak. Adjust the antennas to make sure that the aircraft is within the optimal transmission range.

## Linking the Smart Controller

When the Smart Controller is purchased together with an aircraft, the remote controller has already been linked to the aircraft, and they can be directly used after activating the remote controller and aircraft. If the Smart Controller and the aircraft were purchased separately, follow the steps below to link the remote controller to the aircraft.

1. Power on the aircraft and the remote controller.
2. Press the customizable button C1, C2, and Record button simultaneously. The status LED blinks blue and the controller beeps twice to indicate the linking has started.
3. Press the linking button on the aircraft. The remote controller's status LED will be solid green if the linking is successful.

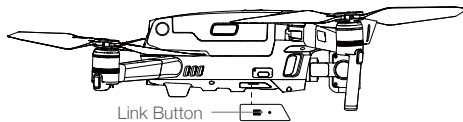

-  • Make sure the remote controller is within 1.6 ft (0.5 m) of the aircraft during linking.
- Make sure the remote controller is connected to the internet when logging in using a DJI account.
  - For more linking methods, visit <https://www.dji.com/smart-controller/downloads> and download the DJI Smart Controller User Manual.

-  • Fully charge the remote controller before each flight.
- If the remote controller is powered on and is not in use for 5 minutes, an alert will sound. After 10 minutes, it will automatically power off. Move the control sticks to cancel the alert.

- ⚠ • Make sure the antennas of the remote controller are unfolded and adjusted to the proper position to achieve optimal transmission quality.
- Repair or replace the remote controller if damaged. A damaged remote controller antenna greatly decreases performance.
- Fully charge the battery at least once every three months to maintain battery health.

## Status LED and Battery Level LEDs Description

The battery level LEDs displays the battery level of the controller. The status LED displays the linking status and warnings when the battery level is low, the temperature is high, and the control sticks are not centered.

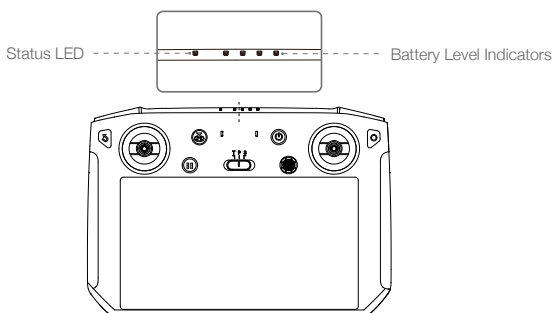



Status LED	Description
Solid Red	The remote controller is not linked to an aircraft.
Solid Green	The remote controller is linked to an aircraft.
Blinks Blue	The remote controller is linking to an aircraft.
Blinks Red	The temperature of the remote controller is too high or the battery level of the aircraft is low.
Blinks Yellow	The battery level of the remote controller is low.
Blinks Cyan	The control sticks are not centered.
Solid Blue	The remote controller firmware updated successfully.
Solid Yellow	The remote controller firmware update failed.

Battery Level Indicators				Battery Level
●	●	●	●	75%~100%
●	●	●	○	50%~75%
●	●	○	○	25%~50%
●	○	○	○	0%~25%

## Smart Controller Warning Sounds

The Smart Controller will vibrate and/or beep when there is a warning prompt. If the error is related to the aircraft or flight status, the remote controller beeps and the status LED is solid green. If the error is related to the Smart Controller, a warning prompt will appear on the screen of the remote controller.

To disable the beeping, power on the remote controller, tap  and then , and disable Notification Volume.

# DJI Pilot App

---

This section introduces the main functions of the DJI Pilot app.

# DJI Pilot App

DJI Pilot is specifically developed for enterprise users and offers two types of flight. Manual flight integrates a variety of professional features that make flying simple and intuitive. Mission flight supports flight planning, and allows users to control the drone automatically, making workflows much simpler and more efficient.

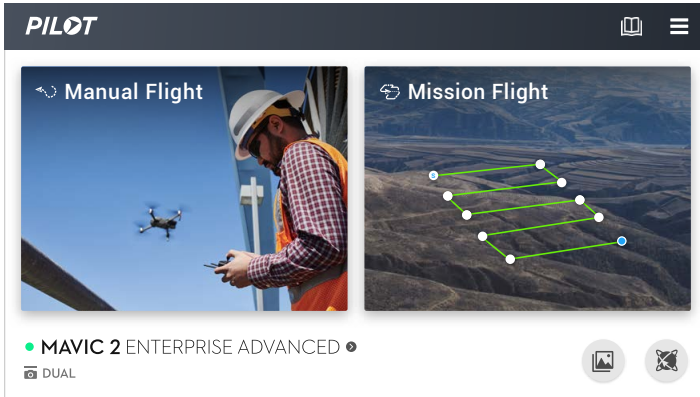

## Manual Flight

### Camera View

Enter the Camera View by tapping Manual Flight.

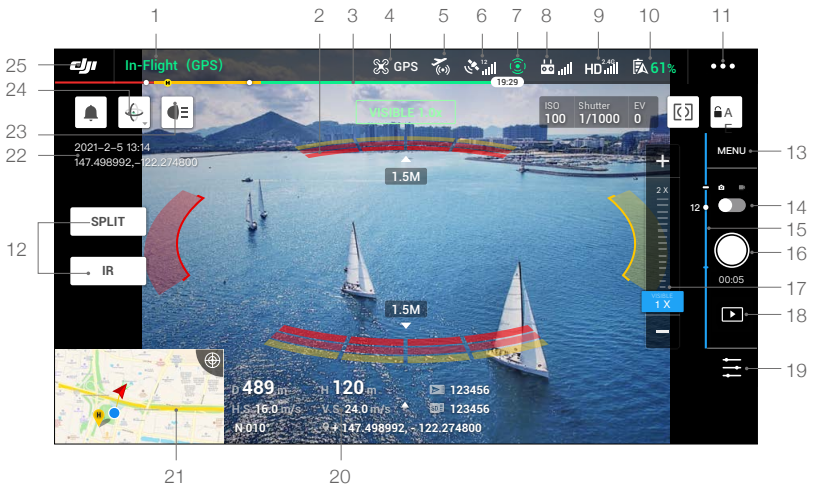

1. System Status Bar

 : indicates aircraft flight status and displays various warning prompts.

2. Obstacle Detection Status

 : red bars are displayed when obstacles are close to the aircraft. Orange bars are displayed when obstacles are within the detection range. Grey bars are displayed when there are no obstacles within the detection range.

3. Battery Level Indicator Bar

 : the battery level indicator provides a dynamic display of the battery level. The colored zones on the battery level indicator represent the power levels needed to carry out different functions.

4. Flight Mode

 : the text next to the icon indicates the current flight mode. Tap to configure the Flight Controller settings. These settings allow you to modify flight limits and set gain values.

5. DJI AirSense Status

 : displays information about nearby manned aircraft to ensure flight safety, including the distance between DJI aircraft and manned aircraft. DJI AirSense will instruct users to land if nearby aircraft are detected.



6. GPS Signal Strength

 : displays the current GPS signal strength. White bars indicate adequate GPS strength.

7. Vision Systems Status

 : displays the status for all Vision Systems. The green icon indicates the corresponding vision system is available while the red icon indicates it is unavailable. Tap the icon settings and enable or disable the features of the Vision Systems.

8. Remote Controller Signal

 : displays the strength of the remote controller signal. The icon will blink when interference is detected during flight. The interference will not affect operation or overall flight experience if there are no additional warning prompts.

9. HD Video Link Signal Strength

 : displays the strength of the HD video downlink connection between the aircraft and the remote controller. The icon will blink when interference is detected during flight. The interference will not affect operation or overall flight experience if there are no additional warning prompts.

10. Battery Settings

 61% : displays the current battery level. Tap to view the battery information, set the various battery warning prompt thresholds, and view the battery warning prompt history.



11. General Settings

 : tap to enter the General Settings to set units of measurement, enable or disable livestream, and more.

12. Display Mode



Tap to switch between the Visible, IR, and Split display modes.

Visible mode: only displays the footage that the visual camera captures.

IR mode: only displays the footage that the infrared thermal camera captures.

Split mode: displays the infrared and visual footage side by side. Spot meter and Area measurement are only available in IR mode.

13. Camera Settings

Tap to enter photo and video settings. Tap  to configure photo settings such as photo mode and image format. Tap  to configure video settings such as video size and format. Tap  to configure the video caption, grid lines, smart arm LED, temperature alerts, gain mode settings, and more.

14. Photo/Video Toggle

 : tap to switch between photo and video recording modes.

15. Gimbal Slider

 : displays the gimbal tilt angle.

16. Shutter/Record Button

 : tap to take a photo or record video. When recording a video, a shutter icon will display on the screen. Tap the icon to take a photo while recording a video.

17. Zoom Menu

a) Visible mode: tap or drag  to adjust the visual camera zoom rate.

b) IR mode: tap  to adjust the thermal camera zoom rate.

c) Split mode: tap  to adjust the zoom rate of the visual camera and thermal camera simultaneously. Users can also use the remote controller dial to zoom.

18. Album

 : tap to preview photos and videos as soon as they are captured.

19. Parameter Settings

 : tap to set exposure values.

20. Flight Telemetry

**D 30 m** : distance between the aircraft and the Home Point.

**H 10.0 m** : height from the Home Point.

**HS 10.0 m/s** : aircraft horizontal speed.

**VS 2.0 m/s** : aircraft vertical speed.

**N 010°**: orientation and angle of the aircraft.

 **113.95, 22.54** Coordinate: longitude and latitude of the aircraft.

 **10:15** : remaining capacity or recording duration of the internal storage.

 **12:45** : remaining capacity or recording duration of the microSD card.



21. Map

Tap to view the map.

22. Time and GPS Information

Displays current date, time, and the longitude and latitude of the aircraft. Only available in Visible mode.

23. Accessory

Shows if an accessory is connected such as the beacon , spotlight  or speaker . Tap to set or use.

24. Gimbal Orientation Adjustment

 : tap to select the Gimbal Orientation Adjustment as Gimbal Recenter, Recenter Gimbal Yaw, Gimbal Yaw Downward or Gimbal Downward.

25. Back

 : tap to return to the main menu.

IR View



1. Palette

☺: Mavic 2 Enterprise Advanced offers a variety of palette options. Distinct colors are used to show temperature differences in the thermal image, which are related to grayscale intensity. The temperature range of the image is mapped to 256 colors and displayed in 8-bit JPEG or MP4 format. The following table shows all palette options.

White Hot	
Fulgurite	
Iron Red	
Hot Iron	
Medical	
Arctic	
Rainbow 1	
Rainbow 2	
Tint	
Black Hot	

2. FFC Calibration

Tap this button to enable FFC calibration in IR Mode. FFC calibration is used to optimize image quality, during which the screen may freeze momentarily.

3. Temperature Measurement

Tap to enable the temperature measurement. Spot Meter and Area Measurement are available in IR mode. Close Area Measurement to exit temperature measurement.

- a) Spot Meter: the temperature of any position in an image can be measured. Refer to the Specifications for more information about measurement accuracy.

- b) Area Measurement: drag an area within the temperature measurement area on the screen. The average temperature, lowest temperature, highest temperature, and corresponding locations of this area will be displayed.

The temperature measurement accuracy is affected by various factors:

- a) Reflectivity of objects – shiny metals with high reflectivity will reflect more of the background radiation and result in lower accuracy, whereas objects with matte surfaces will produce a higher accuracy.
- b) Temperature of background radiation – sunlight has a great influence on the temperature measurement accuracy, direct or reflected sunlight should be avoided from the infrared thermal camera.
- c) Air temperature and humidity – the temperature and humidity have been calibrated before delivery, but some temperature measurement errors are inevitable. Extreme temperatures or humidity levels will affect the measurement accuracy.
- d) Distance between the camera and the object – the default distance used in calibration is 5 m, and the temperature measurement is most accurate at this distance. Deviations from this distance will lower the accuracy.
- e) Emissivity of objects – the emissivity of the object will affect the temperature measurement accuracy. Generally, accuracy increases proportionally to emissivity. Emissivity is affected by factors such as the material, the roughness or the degree of oxidation of the object's surface.



- When measuring a blackbody 5 m away in high gain mode at a windless 25°C indoors, the camera provides an accuracy of up to  $\pm 2^{\circ}\text{C}$  or  $\pm 2\%$  (whichever is the larger value). Since the emissivity of different objects varies, this measurement result only represents the accuracy of the tested blackbody, for reference only.
- 

#### 4. Visual Camera FOV

[ ]: the visual camera FOV range in IR mode. The FOV range will change if the zoom of the visual camera is adjusted.

## Mission Flight

### Introduction

Tap to enter the mission library. View created flight routes or the most recent Waypoint flights, Mapping missions, or Oblique Photography missions. Mapping and Oblique Photography missions are generated using the app and Waypoint flights can be created by selecting Set Waypoints or Live Mission Recording.



Use Set Waypoints to create a route by adding editable waypoints on the map. Use Live Mission Recording to create a route by recording the position information along the route.

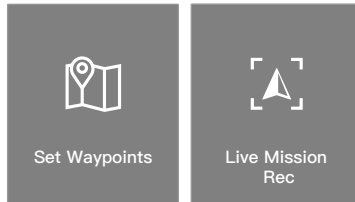

## Set Waypoints

Tap Create a Route, Waypoint Flight, and then Set Waypoints to create a new flight route and edit waypoints.

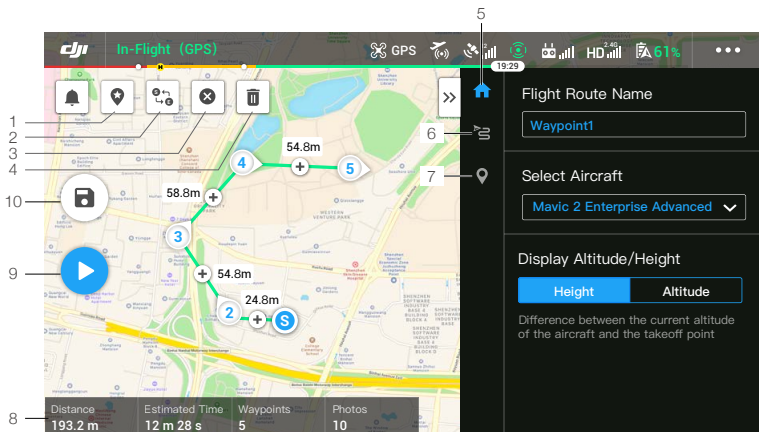

Tap on the map to add waypoints and configure route and waypoints settings.

### 1. Point of Interest (POI)

: tap to enable POI. A POI will be displayed on the map and can be dragged to adjust the position. When POI is enabled, the yaw of the aircraft can be set to center on the POI so that the aircraft front points at the POI during the mission. Tap this icon again to disable POI.

### 2. Reverse Path

: tap to swap the start and end points, which reverses the flight path. S refers to the start point.

### 3. Clear Waypoints

: tap to clear all the added waypoints.

### 4. Delete Selected Waypoint

: tap to delete the selected waypoint.

### 5. Parameters List

Edit the route name, set the aircraft type as Mavic 2 Enterprise Advanced, and configure the gimbal and camera.

### 6. Route Settings

Route settings are applied to the entire route including action upon completion, gimbal control, and aircraft speed, height, and yaw.

### 7. Waypoint Settings

Select a waypoint and set waypoint parameters. Tap < or > to switch to the previous or next

waypoint. The settings are applied to the selected waypoint including aircraft speed, height, yaw, longitude, latitude, and waypoint type and actions.

8. Mission Information

Displays the flight length, estimated flight time, waypoint quantity, photo quantity, longitude, and latitude.

9. Perform

 : tap and check the settings and status of the aircraft in the pop-up checklist. Tap Start to Fly to perform the mission.

10. Save

 : tap to save current settings.

Waypoints Editing

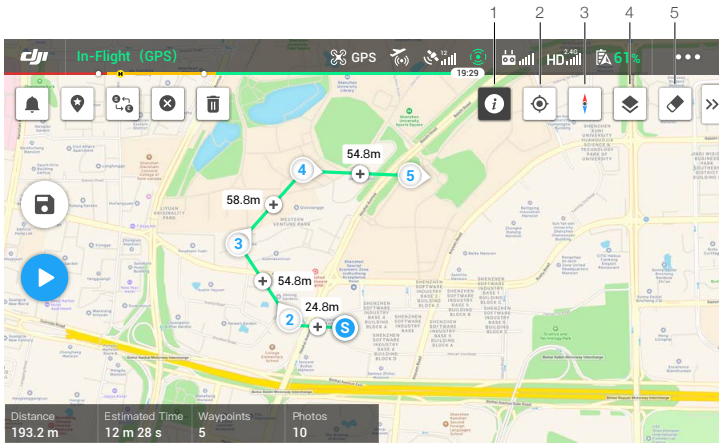

Enter the mission library, select a created flight route, and tap  to edit the flight route.

1. Flight Restriction Information

 : tap to view the flight restriction information.

2. Location

 : tap to center the map around the location of the aircraft.

3. Map Lock

 : map rotation is locked by default with north at the top of the map. Tap to unlock rotation. Hold two fingers on the map and rotate to adjust the orientation.

4. Map Mode

 : tap to switch between Standard and Satellite modes.

5. Clear Screen

 : tap to clear the flight path currently shown on the map.

Live Mission Recording

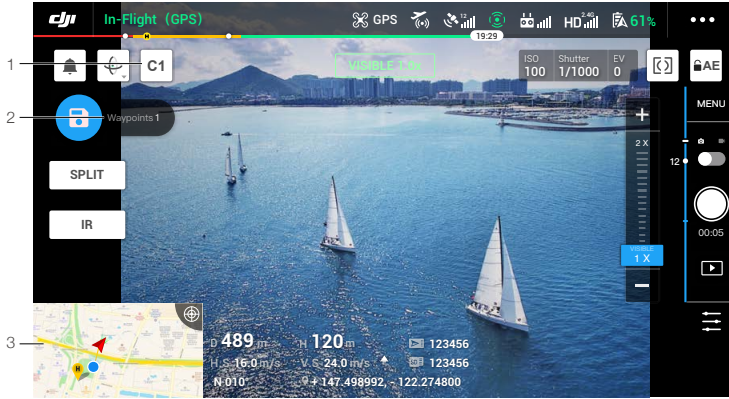

1. Tap C1 to add a new waypoint.
2. Total number of waypoints.
3. Tap to enter the map for editing. Tap  to save current settings and a flight route is created.



## Album

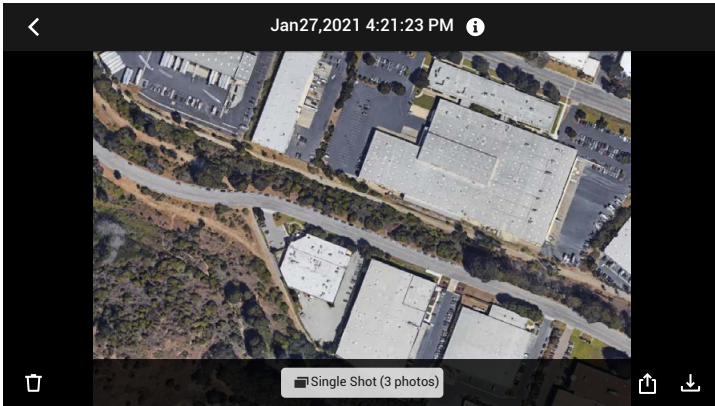

Tap to view photos or videos that can be saved to a mobile device.

When saving a photo or video, the format will vary depending on the display mode. Refer to the Storing the Photos and Videos section for more information. Tap **Single Shot (3 photos)** to switch between the footage of the photo or video.

# Flight

---

This section describes safe flight practices and flight restrictions.

# Flight

Once pre-flight preparation is complete, it is recommended to hone your flight skills and practice flying safely. Make sure that all flights are carried out in an open area. The flight height is limited to 500 m. DO NOT exceed this height. Strictly abide by local laws and regulations when flying. Make sure to read the Mavic 2 Enterprise Series Disclaimer and Safety Guidelines to understand the safety notices before flying.

## Flight Environment Requirements

1. Do not use the aircraft in severe weather conditions including wind speeds exceeding 10 m/s, snow, rain, and fog.
2. Only fly in open areas. Tall structures and large metal structures may affect the accuracy of the onboard compass and GPS system.
3. Avoid obstacles, crowds, high voltage power lines, trees, and bodies of water.
4. Minimize interference by avoiding areas with high levels of electromagnetism such as locations near power lines, base stations, electrical substations, and broadcasting towers.
5. Aircraft and battery performance is subject to environmental factors such as air density and temperature. Exercise extreme caution when flying 19,685 ft (6,000 m) or more above sea level since battery and aircraft performance may be reduced.
6. The aircraft cannot use GPS within the polar regions. Use the Downward Vision System when flying in such locations.

## Flight Limits and GEO Zones



Abide by all laws and regulations when flying the aircraft. Flight limitations are applied by default to help users operate the aircraft safely and legally. Flight limitations include altitude limits, distance limits, and GEO zones.

Altitude limits, distance limits, and GEO Zones function concurrently to manage flight safety when operating in P-mode.

### Flight Altitude and Distance Limits

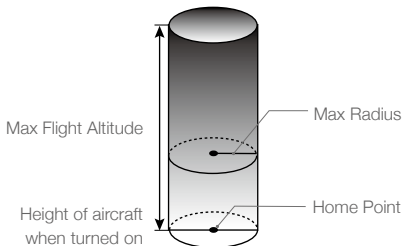
The flight altitude and distance limits can be set in DJI Pilot. The maximum flight altitude setting cannot exceed 1,640 ft (500 m). Based on these settings, the aircraft will fly in a restricted cylinder as shown below.



GPS Signal Strong  ..... Blinking Green			
	Flight Limits	DJI Pilot App	Aircraft Status Indicator
Max Altitude	Altitude of the aircraft cannot exceed the specified value.	Warning: Height limit reached.	N/A
Max Radius	Flight distance must be within the max radius.	Warning: Distance limit reached.	Blinks red quickly  ..... when close to the max radius limit.

GPS Signal Weak  ..... Blinking Yellow			
	Flight Limits	DJI Pilot App	Aircraft Status Indicator
Max Altitude	Height is restricted to 16 ft (5 m) when the GPS signal is weak and Downward Vision System is activated. Height is restricted to 98 ft (30 m) when the GPS signal is weak and Downward Vision System is inactivate.	Warning: Height limit reached.	N/A
Max Radius	No limit		



- If the aircraft reaches one of the limits, users can still control the aircraft, but cannot fly it any farther. If the aircraft flies out of the max radius, it will automatically fly back within range when the GPS signal is strong.
- For safety reasons, do not fly close to airports, highways, railway stations, railway lines, city centers, or other sensitive areas. Only fly the aircraft within visual line of sight.

## GEO Zones

All GEO Zones are listed on the DJI official website at <http://www.dji.com/flysafe>. GEO Zones are divided into different categories and include locations such as airports, flight areas where manned aircraft operate at low altitudes, international borders, and sensitive locations such as power plants.

## Pre-Flight Checklist

1. Make sure the remote controller, mobile device, and Intelligent Flight Battery are fully charged.
2. Make sure the Intelligent Flight Battery and the propellers are mounted securely.
3. Make sure the aircraft arms and propellers are unfolded.
4. Make sure the gimbal and camera are functioning normally.
5. Make sure that there is nothing obstructing the motors and that they are functioning normally.
6. Make sure that DJI Pilot is successfully connected to the aircraft.
7. Make sure all camera lenses and sensors are clean.
8. Make sure all accessories are correctly and securely mounted on the aircraft before use.
9. Use only genuine DJI parts or parts certified by DJI. Unauthorized parts or parts from non-DJI certified manufacturers may cause system malfunctions and compromise safety.

## Starting/Stopping the Motors

### Starting the Motors

A Combination Stick Command (CSC) is used to start the motors. Push both sticks to the inner or outer bottom corners to start the motors. Once the motors have started spinning, release both sticks simultaneously.

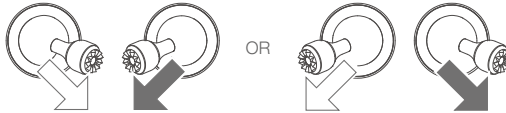

### Stopping the Motors

There are two methods to stop the motors:

Method 1: when the aircraft has landed, push and hold the left control stick down. The motors stop after three seconds.

Method 2: when the aircraft has landed, perform the same CSC that was used to start the motors as described above. The motors stop immediately. Release both sticks once the motors have stopped.

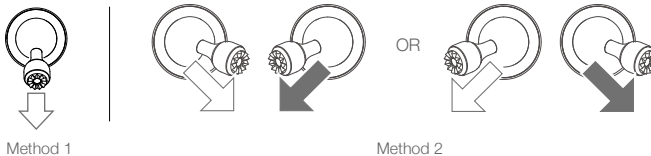

### Stopping Motors Mid-Flight

Stopping the motors mid-flight will cause the aircraft to crash. The motors should only be stopped mid-flight in an emergency situation such as if the aircraft is involved in a collision, a motor has stalled, the aircraft is rolling in the air, or the aircraft is out of control and is ascending or descending very quickly. To stop the motors mid-flight, perform the same CSC that was used to start the motors.

## Flight Test

### Takeoff/Landing Procedures

1. Place the aircraft in an open, flat area with the Aircraft Status Indicators facing towards you.
2. Power on the aircraft and the remote controller.
3. Launch DJI Pilot and enter the live view.
4. Wait until the Aircraft Status Indicator blinks green indicating that the Home Point has been recorded and it is now safe to fly.
5. Push the throttle stick up slowly to take off.
6. To land, hover over a level surface and gently push the throttle stick down to descend.
7. After landing, hold the throttle stick down completely until the motors stop.
8. Power off the Intelligent Flight Battery before the remote controller.

### Video Suggestions and Tips

1. The pre-flight checklist is designed to help you fly safely and to make sure that you can shoot video during flight. Go through the full pre-flight checklist before each flight.
2. Select the gimbal operation mode in DJI Pilot.
3. Only shoot video when flying in P-mode or T-mode.
4. DO NOT fly in adverse weather conditions such as when it is raining or windy.
5. Choose the camera settings that best suit your needs. Settings include photo format and exposure compensation.
6. Perform flight tests to establish flight routes and to preview scenes.
7. Push the control sticks gently to keep the aircraft movement smooth and stable.



It is important to understand the basic flight guidelines for the safety of both you and those around you.

DO NOT forget to read the **disclaimer and safety guidelines**.

---

# Appendix

---

# Appendix

## Specifications

Aircraft	
Takeoff Weight (excl. accessories)	909 g
Max Takeoff Weight	1100 g
Dimensions	Folded: 214×91×84 mm Unfolded: 322×242×84 mm
Diagonal Distance	354 mm
Max Ascent Speed	6 m/s (S-mode) 5 m/s (P-mode)
Max Descent Speed	<b>Vertical Descent</b> 5 m/s (S-mode) 4 m/s (P-mode) <b>Tilt</b> 7 m/s (S-mode) 4 m/s (P-mode)
Max Speed	72 kph (S-mode, without wind)
Max Service Ceiling Above Sea Level	6000 m
Max Flight Time	31 min (measured while flying at 25 kph in windless conditions) 28 min (RTK module attached) 29 min (with beacon powered on) 30 min (with beacon powered off) 24 min (with spotlight powered on) 28 min (with spotlight powered off) 27 min (with speaker powered on) 28 min (with speaker powered off)
Max Wind Speed Resistance	10 m/s (scale 5)
Max Tilt Angle	35° (S-mode, with remote controller) 25° (P-mode)
Max Angular Velocity	200°/s (S-mode) 100°/s (P-mode)
Operating Temperature Range	14° to 104° F (-10° to 40° C)
GNSS	
Hovering Accuracy Range	<b>Vertical:</b> ± 0.1 m (with RTK) ± 0.1 m (with Vision Positioning) ± 0.5 m (with GPS Positioning) <b>Horizontal:</b> ± 0.1 m (with RTK) ± 0.3 m (with Vision Positioning) ± 1.5 m (with GPS Positioning)
Operating Frequency	2.4-2.4835 GHz; 5.725-5.850 GHz
Transmitter Power (EIRP)	2.4 GHz FCC: ≤26 dBm; CE: ≤20 dBm; SRRC: ≤20 dBm; MIC: ≤20 dBm 5.8 GHz FCC: ≤26 dBm; CE: ≤14 dBm; SRRC: ≤26 dBm
Internal Storage	24 GB



<b>Thermal Camera</b>	
Sensor	Uncooled VOx Microbolometer
Focal Length	Approx. 9 mm 35mm Format Equivalent: Approx. 38 mm
Sensor Resolution	640×512 @30Hz
Digital Zoom	16×
Pixel Pitch	12 μm
Spectral Band	8-14 μm
Image Size	640×512
Still Photography Modes	Single shot Interval: 2/3/5/7/10/15/20/30/60 s
Video Resolution	640×512@30fps
Supported File Formats	FAT32, exFAT
Photo Format	R-JPEG
Video Format	MP4
Temperature Measurement Method	Spot Meter, Area Measurement
FFC	Auto/Manual
<b>Visual Camera</b>	
Sensor	1/2" CMOS, Effective Pixels: 48 MP
Lens	FOV: approx. 84° 35 mm format equivalent: 24 mm Aperture: f/2.8 Focus: 1 m to ∞
Digital Zoom	Video: zoom is only supported in 1080p; up to ×4 digital zoom is supported in the live view and during recording Photos: up to ×32 digital zoom is supported in the live view
ISO Range	Video: 100-12800 (auto) Photo: 100-1600 (auto)
Shutter Mode	Mode P (Programmed Auto)
Max Image Size	8000×6000
Still Photography Modes	Single Shot Interval: 2/3/5/7/10/15/20/30/60 s Panorama: Sphere
Video Resolution	3840×2160@30fps 1920×1080@30fps
Max Video Bitrate	95.37 Mb/s
Supported File Formats	FAT32, exFAT
Photo Format	JPEG
Video Format	MP4
<b>Gimbal</b>	
Controllable Range	Tilt: -90° to +30° Pan: -75° to +75°
Mechanical Range	Tilt: -135° to +45° Roll: -45° to +45° Pan: -100° to +100°

Stabilization	3-axis (tilt, roll, pan)
Max Controllable Speed	120°/s
Angular Vibration Range	±0.005°
<b>Sensing System</b>	
Sensing System	Omnidirectional Obstacle Sensing
FOV	(Forward) Horizontal: 40°, Vertical: 70° (Backward) Horizontal: 60°, Vertical: 77° (Downward) Front and Back: 100°, Left and Right: 83° (Lateral) Horizontal: 80°, Vertical: 65°
Obstacle Sensing Range	(Forward) Precision Measurement Range: 0.5 - 20 m Detectable Range: 20 - 40 m Effective Sensing Speed: ≤ 14 m/s (Backward) Precision Measurement Range: 0.5 - 16 m Detectable Range: 16 - 32 m Effective Sensing Speed: ≤ 12 m/s (Downward) Precision Measurement Range: 0.5 - 11 m Detectable Range: 11 - 22 m (Lateral) Precision Measurement Range: 0.5 - 10 m Effective Sensing Speed: ≤ 8 m/s (Upward) Precision Measurement Range: 0.1 - 8 m
Operating Environment	Surface with a clear pattern and adequate lighting (lux >15) Diffuse reflective surface such as walls, trees, people (>20%)
Velocity Range	≤ 31mph (50 kph) (at 6.6 ft (2 m) above ground)
Altitude Range:	0.1 to 11 m
Operating Range	0.3 to 50 m
<b>Remote Controller</b>	
<b>Ocusync 2.0</b>	
Operating Frequency	2.4-2.4835 GHz; 5.725-5.850 GHz
Max Transmission Distance (unobstructed, free of interference)	FCC: 10 km, CE/SRRC/MIC: 6 km
Transmission Power (EIRP)	2.4 GHz FCC: ≤25.5 dBm; CE/MIC: ≤18.5 dBm; SRRC: ≤19 dBm 5.8 GHz FCC: ≤25.5 dBm; CE: ≤12.5 dBm; SRRC: ≤18.5 dBm
<b>Wi-Fi</b>	
Protocol	Wi-Fi Direct, Wi-Fi Display, 802.11a/g/n/ac Wi-Fi with 2x2 MIMO is supported
Operating Frequency	2.400-2.4835 GHz; 5.725-5.850 GHz
Transmission Power (EIRP)	2.4 GHz FCC: ≤21.5 dBm; CE/SRRC: ≤18.5 dBm; MIC: ≤20.5 dBm 5.8 GHz FCC/SRRC: ≤21 dBm; CE: ≤13 dBm
<b>Bluetooth</b>	
Protocol	Bluetooth 4.2
Operating Frequency	2.400-2.4835 GHz
Transmission Power (EIRP)	≤4 dBm

**Others**

Battery	18650 Li-ion (5000 mAh @ 7.2 V)
Charging Mode	Charged with USB charger at 12 V/2 A
Rated Power	15 W
Storage	ROM 16GB + expandable storage via microSD card*
Charging Time	2 hours (with a USB charger at 12 V/2 A)
Power Supply	2 hours 30 minutes
Video Output Port	HDMI Port
Supply Current/Voltage of the USB-A Port	5 V/900 mA
Operating Temperature Range	-20° to 40° C (-4° to 104° F)
Storage Temperature	<1 month: -30° to 60° C (-22° to 140° F) 1 - 3 months: -30° to 45° C (-22° to 113° F) 3 - 6 months: -30° to 35° C (-22° to 95° F) >6 months: -30° to 25° C (-22° to 77° F)
Charging Temperature	5° to 40° C (41° to 104° F)
Recommended microSD Cards:	SanDisk Extreme 32GB UHS-3 microSDHC SanDisk Extreme 64GB UHS-3 microSDXC Panasonic 32GB UHS-3 microSDHC Panasonic 64GB UHS-3 microSDXC Samsung PRO 32GB UHS-3 microSDHC Samsung PRO 64GB UHS-3 microSDXC Samsung PRO 128GB UHS-3 microSDXC
Satellite Positioning Module	GPS+GLONASS
Dimensions	177.5x121.3x40 mm (folded without control sticks) 177.5x181x60 mm (unfolded with control sticks)
Weight	Approx. 630 g
24W USB Charger	Input: 100-240 V, 50-60 Hz, Max. 0.8 A Output: 3.6-8 V $\mp$ 3.0 A/12 V $\mp$ 2.0 A

**Intelligent Flight Battery**

Capacity	3850 mAh
Voltage	17.6 V (max) 15.4 V (typical)
Battery Type	LiPo
Energy	59.29 Wh
Weight	Approx. 297 g
Charging Temperature	5° to 40° C (41° to 104° F)
Operating Temperature Range	-10° to 40° C (14° to 104° F)
Heating Method	Manual/Auto
Heating Temperature Range	-4° to 43° F (-20° to 6° C)
Heating Time	500 s (max)
Heating Power	55 W (max)
Charging Time	1 hour 30 minutes
Max Charging Power	80 W

<b>Charger</b>	
Input	100-240 V, 50-60 Hz, Max. 0.8 A
Output	Main: 17.6 V $\approx$ 3.41 A or 17.0 V $\approx$ 3.53 A USB: 5 V $\approx$ 2 A
Rated Power	60 W
<b>APP</b>	
Name	DJI Pilot (Android version)
Video Transmission System	OcuSync 2.0
Live View Quality	720p@30fps
Latency (depending on environment and mobile device)	120 - 130 ms
<b>M2EA RTK Module</b>	
Dimensions	69×69×59 mm
Port Type	USB Micro-B
Power	Approx. 3 W
GNSS	GPS L1/L2, GLONASS F1/F2, BDS B1/B2, GALILEO E1/E5
RTK Position Accuracy	In RTK FIX 1cm+1ppm (Horizontal)   1.5cm+1ppm (Vertical)
<b>M2E Beacon</b>	
Dimensions	68×40×27.8 mm
Port Type	USB Micro-B
Power	Avg. 1.6 W
Illuminance	Min. angle: 55 cd; light intensity: 157 cd
Max. Visible Distance	5,000 m (with good air quality and high visibility)
<b>M2E Spotlight</b>	
Dimensions	68×60×41 mm
Port Type	USB Micro-B
Power	Max. 26 W
Illuminance	FOV 17°, max. 11 lux @ 30 m straight
Illumination area	30 m
<b>M2E Speaker</b>	
Dimensions	68×55×65 mm
Port Type	USB Micro-B
Power	Max. 10 W
Decibel	100 dB at 1 m (international standard)
Bit Rate	16 kbps

\* The DJI Smart Controller supports a microSD with a capacity of up to 128 GB.

## Calibrating the Compass

### Aircraft

It is recommended to calibrate the compass in any of the following situations when flying outdoors:

1. Flying in a location more than 31 miles (50 km) away from the location the drone was last flown.
2. The aircraft has not been flown for more than 30 days.
3. A compass interference warning prompt appears in DJI Pilot and/or the Aircraft Status Indicators blink red and yellow alternately.



- DO NOT calibrate the compass in locations where magnetic interference may occur, such as close to magnetite deposits or large metallic structures such as parking structures, steel reinforced basements, bridges, cars, or scaffolding.
- DO NOT carry objects such as cell phones that contain ferromagnetic materials near the aircraft during calibration.
- It is not necessary to calibrate the compass when flying indoors.

### Calibration Procedure

Choose an open area to carry out the following procedure.

1. Tap the System Status Bar in DJI Pilot, select Calibrate, and follow the on-screen instructions.
2. Hold the aircraft horizontally and rotate it 360°. The Aircraft Status Indicator will turn solid green.
3. Hold the aircraft vertically with the front pointing downward and rotate it 360° around a vertical axis.
4. If the Aircraft Status Indicator blinks red, calibration has failed. Change locations and try calibration again.

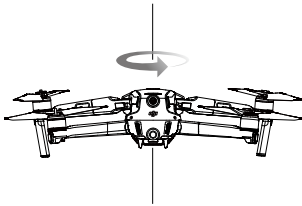

Horizontal Calibration



Vertical Calibration

If the Aircraft Status Indicator blinks red and yellow alternately after calibration is completed, this indicates the current location is unsuitable for flying the aircraft due to the level of magnetic interference. Choose a new location.



- A prompt will appear in DJI Pilot if compass calibration is required before takeoff.



- The aircraft can take off immediately once calibration is complete. If users wait more than three minutes to take off, the aircraft may need to be calibrated again. It is possible that another compass interference warning will appear while the aircraft is on the ground. This indicates that the current location is unsuitable for flying the aircraft due to the level of magnetic interference.

## Smart Controller

After the remote controller is used in locations with electro-magnetic interference, the compass may need to be calibrated. A warning prompt will appear if the compass requires calibration. Tap the warning prompt to start calibrating. When a prompt does not appear, follow the steps below to calibrate the remote controller.

1. Enter the App Center, tap , then scroll down and tap Compass.
2. Follow the onscreen diagram to calibrate the remote controller.
3. A prompt will appear when calibration is successful.

## Updating Firmware

### Aircraft

Use DJI Pilot or DJI Assistant 2 (Enterprise Series) to update the aircraft firmware.

### Using DJI Pilot

When the aircraft or remote controller is connected to DJI Pilot, a prompt will appear if a new firmware update is available. To update, connect the mobile device to the internet and follow the onscreen instructions. The firmware cannot be updated if the remote controller is not linked to the aircraft.

### Using DJI Assistant 2 (Enterprise Series)

The USB-C port is used when connecting the aircraft to a computer to update firmware. Follow the instructions below to update the firmware through DJI Assistant 2 (Enterprise Series):

1. With the aircraft is powered off, connect the aircraft to a computer via the Micro USB port using a Micro USB cable.
2. Power on the aircraft.
3. Launch DJI Assistant 2 (Enterprise Series) and log into a DJI account.
4. Select Mavic 2 and click on Firmware Updates on the left panel.
5. Select the firmware version to update to.
6. Wait for the firmware to download. The firmware update will start automatically.
7. Reboot the aircraft after the firmware update is complete.



- Make sure the aircraft is connected to the computer before powering on.
  - The firmware update will take approximately 15 minutes. It is normal for the gimbal to go limp, the aircraft status indicators to blink, and the aircraft to reboot during the update. Wait until the update is complete.
  - Make sure the computer is connected to the internet.
  - Before performing an update, make sure the Intelligent Flight Battery and the remote controller have at least 50% power.
  - Do not disconnect the aircraft from the computer during an update.
  - Note that the update may reset various main controller settings, such as the RTH altitude and the maximum flight distance, to default settings. Before updating, take note of your preferred DJI Pilot settings and readjust them after the firmware update.
-





- Keep people and animals at a safe distance during any firmware update, system calibration, or parameter setting procedures.
- For safety, always update to the latest firmware version.
- If a firmware update is available, users will be prompted to update immediately or within three days. If the firmware update is ignored, users are required to agree to the disclaimer. The user's decision not to update to the latest firmware is recorded to be uploaded and maintained on a DJI designated server.
- The remote controller may unlink from the aircraft after updating firmware. Re-link the remote controller and aircraft.
- Make sure to check all connections and remove the propellers from the motors before updating firmware.

## Smart Controller

### Method 1: Wireless

Make sure the remote controller is connected to the internet while updating.

1. Power on the remote controller. Tap  and then , and scroll to the bottom of the page and tap System Update.
2. Tap Check for Updates to check the firmware. A prompt will appear if a firmware update is available.
3. Follow the prompts to finish the update.
4. The remote controller automatically restarts when the update is complete.

### Method 2: DJI Assistant 2 (Enterprise Series)

1. Make sure the remote controller is powered off and connect it to a computer using a USB 3.0 Type-C cable.
2. Power on the remote controller.
3. Launch DJI Assistant 2 and log in using a DJI account.
4. Click the Smart Controller icon and then Firmware Update.
5. Select and confirm the firmware version to update to.
6. DJI Assistant 2 will download and update the firmware automatically.
7. The remote controller will restart when the update is complete.



- Make sure the remote controller has a battery level of more than 50% before updating.
- DO NOT disconnect the USB-C cable during the update.
- Make sure the remote controller or the computer is connected to the internet during the update. The update takes approximately 15 minutes.

## After-Sales Information

Visit <https://www.dji.com/support> to learn more about after-sales service policies, repair services and support.

DJI Support  
<http://www.dji.com/support>

This content is subject to change.

**Download the latest version from**  
**[www.dji.com/mavic-2-enterprise-advanced](http://www.dji.com/mavic-2-enterprise-advanced)**

If you have any questions about this document, please contact DJI  
by sending a message to **[DocSupport@dji.com](mailto:DocSupport@dji.com)**.

MAVIC is a trademark of DJI.  
Copyright © 2021 DJI All Rights Reserved.